

medartis

PRECISION IN FIXATION

SURGICAL TECHNIQUE

Mid- and Hindfoot System 2.8/3.5

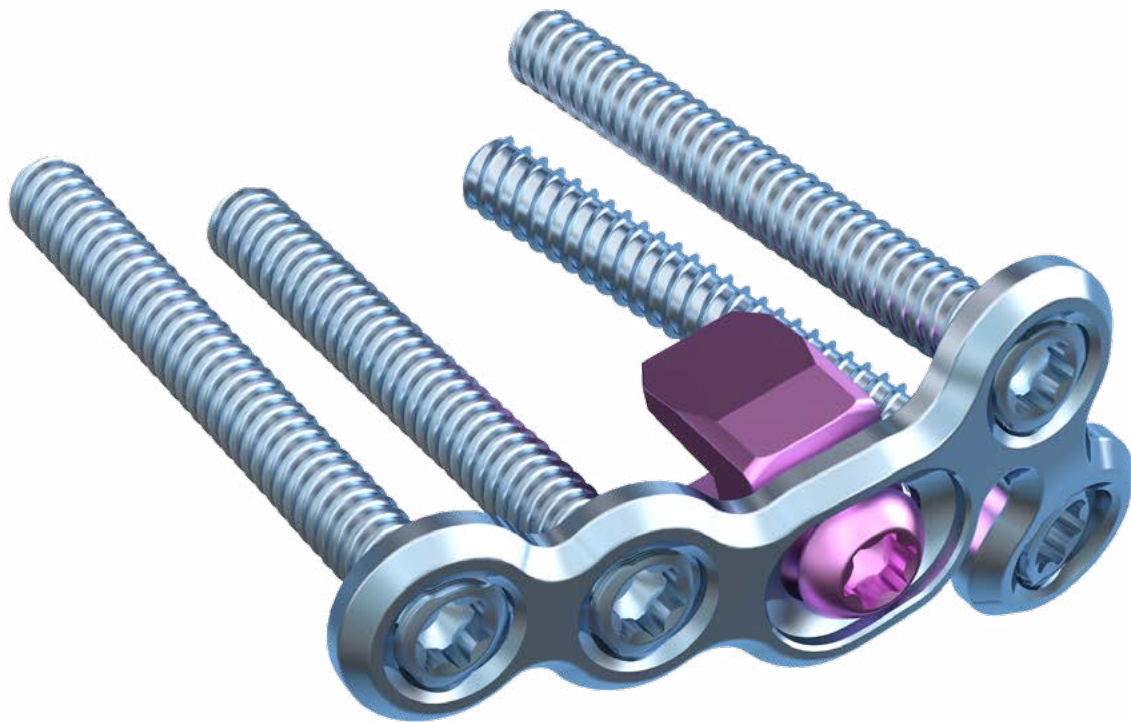

APTUS Foot

Contents

3	Introduction
3	Product Materials
3	Indications
3	Contraindications
3	Color Coding
3	Possible Combination of Plates and Screws
3	Symbols
4	System Overview
6	Treatment Concept
7	Instrument Application
7	General Instrument Application
7	Sizing Templates
8	Plate Holding and Positioning
8	Bending
10	Cutting
11	Drilling
13	Assigning the Screw Length
14	Screw Pick-Up
16	Specific Instrument Application
16	K-Wire Spreader for 1.6 or 2.0 mm K-Wires
16	Lamina Spreader
17	Surgical Techniques
17	General Surgical Techniques
17	Lag Screw Technique
20	Specific Surgical Techniques
20	Wedges Small and Large for Plates 2.8/3.5
23	2.8 TriLock C Plates
24	2.8 TriLock Calcaneus LCL Plates
24	3.5 TriLock Calcaneus LCL Plates
26	3.5 TriLock Calcaneus Step Plates
27	Explantation
27	Explantation of Mid- and Hindfoot Plates
28	TriLock Locking Technology
28	Correct Application of the TriLock Locking Technology – 2.8 TriLock Screws
29	Correct Application of the TriLock Locking Technology – 3.5 TriLock Screws
30	Correct Locking ($\pm 15^\circ$) of the TriLock Screws in the Mid- and Hindfoot System 2.8/3.5
31	Implants, Instruments and Containers

For further information regarding the APTUS product line visit www.medartis.com

Introduction

Product Materials

Plates and Screws

Unalloyed titanium (ASTM F67, ISO 5832-2),
titanium alloy (ASTM F136, ISO 5832-3)

Wedges

Titanium alloy (ASTM F136, ISO 5832-3)

K-Wires

Stainless steel (ASTM F139, ISO 5832-1)

Instruments

Stainless steel, aluminum, aluminum alloy, unalloyed titanium (ASTM F67, ISO 5832-2), Nitinol, PA, PEEK, POM, PP, PPSU, PTFE, silicone

Containers

Stainless steel, aluminum alloy, PEEK, PP, PPSU, silicone

Indications

APTUS Foot

Fractures, osteotomies and arthrodesis of the bones of the foot

- Mid- and Hindfoot System
- osteotomies and arthrodeses of the tarsals and metatarsals

Contraindications

- Preexisting or suspected infection at or near the implantation site
- Known allergies and/or hypersensitivity to implant materials
- Inferior or insufficient bone quality to securely anchor the implant
- Patients who are incapacitated and/or uncooperative during the treatment phase
- Growth plates are not to be blocked with plates and screws

Color Coding

System Size	Color Code
2.8	Orange
3.5	Green

Plates and Screws

Special implant plates and screws have their own color:

Implant plates blue	TriLock plates (locking)
Implant screws gold	Cortical screws (fixation)
Implant screws blue	TriLock screws (locking)
Implant screws pink	Cancellous screws (fixation)
Implant wedges purple	Wedges and wedge screw

Possible Combination of Plates and Screws

Plates, screws and wedges can be combined within one system size:

2.8 TriLock Plates

- 2.8 TriLock Screws, HexaDrive 7
- 2.8 Cortical Screws, HexaDrive 7
- 2.8/3.5 Wedges Small/Large for Plates
- 2.8 Wedge Screw, HexaDrive7

3.5 TriLock Plates

- 3.5 TriLock Screws, HexaDrive 15
- 3.5 Cortical Screws, HexaDrive 15
- 2.8/3.5 Wedges Small/Large for Plates
- 3.5 Wedge Screw, HexaDrive 15
- 4.0 Cancellous Screws, HexaDrive 15

Symbols

 HexaDrive





 TriLock screw hole on sizing templates

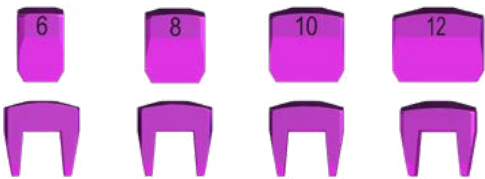

System Overview

The plates of the Mid- and Hindfoot System 2.8 / 3.5 are available in different sizes in left and right versions. The plates are available sterile and non-sterile.

System	System Size		Plate Thickness
Mid- and Hindfoot System 2.8/3.5	2.8	TriLock C Plates	1.6 mm
		 A-4850.73 Small A-4850.72 Large	
		TriLock Calcaneus Lateral Column Lengthening (LCL) Plates	
		 A-4850.83 Left Small A-4850.84 Right Small A-4850.81 Left Large A-4850.82 Right Large	
	3.5	TriLock Calcaneus Lateral Column Lengthening (LCL) Plates	2.0 mm
		 A-4950.83 Left Small A-4950.84 Right Small A-4950.81 Left Large A-4950.82 Right Large	
		TriLock Calcaneus Step Plates	
		 A-4950.06 Step 06 mm A-4950.08 Step 08 mm A-4950.10 Step 10 mm A-4950.12 Step 12 mm A-4950.14 Step 14 mm	

System	System Size	
Wedge System 2.8/3.5	2.8/3.5	Wedges, Small
		  A-4099.10 04 mm A-4099.11 05 mm A-4099.12 06 mm A-4099.13 07 mm
		Wedges, Large
		  A-4099.20 06 mm A-4099.21 08 mm A-4099.22 10 mm A-4099.23 12 mm
Wedge System 2.8/3.5	2.8	Wedge Screw  A-4099.01/1 09 mm, HD7
	3.5	 A-4099.02/1 11 mm, HD15

Treatment Concept

The table below lists typical clinical findings which can be treated with the implants of the Mid- and Hindfoot System 2.8/3.5.

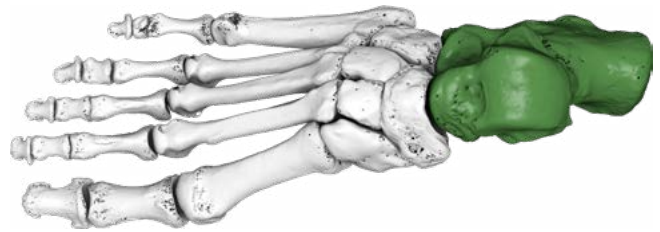
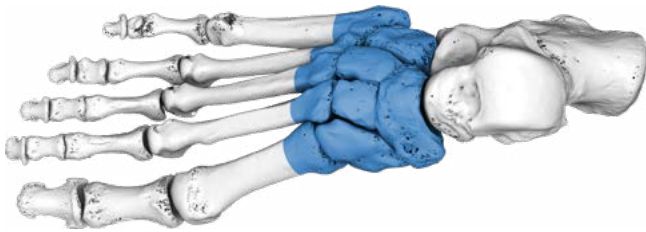

Midfoot

	C Plate 2.8 A-4850.72-73				
	Calcaneus LCL Plate 2.8 A-4850.81-84				
	Calcaneus LCL Plate 3.5 A-4950.81-84				
	Calcaneus Step Plate 3.5 A-4950.06/08/10/12/14				
	Small/Large Wedge 2.8/3.5 A-4099.10-13/20-23				
Medial Cuneiform Dorsal Opening Wedge (Cotton) Osteotomy					

Hindfoot

	C Plate 2.8 A-4850.72-73				
	Calcaneus LCL Plate 2.8 A-4850.81-84				
	Calcaneus LCL Plate 3.5 A-4950.81-84				
	Calcaneus Step Plate 3.5 A-4950.06/08/10/12/14				
	Small/Large Wedge 2.8/3.5 A-4099.10-13/20-23				
Calcaneal Sliding Osteotomy					
Lateral Column Lengthening (Evans Osteotomy)					

The above-mentioned information is a recommendation only. The operating surgeon is solely responsible for the choice of the suitable implant for the specific case.

Instrument Application

General Instrument Application

Sizing Templates

Sizing templates facilitate the intraoperative selection of the appropriate implant. Sizing templates for the Mid- and Hindfoot System 2.8/3.5 are available according to chapter "Implants, Instruments and Containers".

The sizing templates feature symbols that indicate the type of the screw hole and its position on the respective implant:



for a TriLock screw hole (locking) using a TriLock or cortical screw

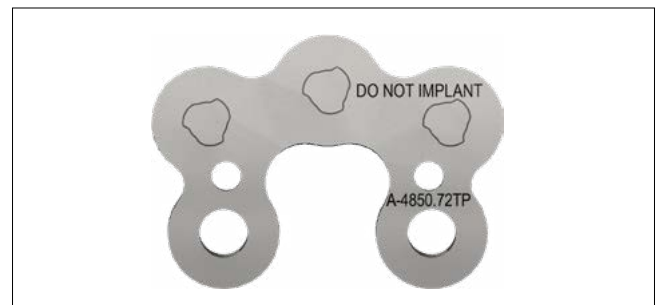

Sizing template with TriLock screw hole symbols

The article number of the sizing template (e.g. A-4850.72TP) corresponds to the article number of the sterile implant (e.g. A-4850.72S). The suffix TP stands for template.



A-4850.72TP
Template for A-4850.72S

Use appropriate K-wires to temporarily fix the sizing template to the bone, if necessary.

Notice

Do not implant sizing templates.
Do not bend or cut sizing templates.

Plate Holding and Positioning

The plates can be manually removed from the implant container or with the help of the plate holding forceps (A-2050). These forceps have a crossed end and will open when pressure is applied. The plates are kept force-free in the holding channel of the forceps tip.



A-2050
2.0–3.5 Plate Holding Forceps

The TriLock ends of the 2.8/3.5 plate holding and positioning instrument (A-2950) can be locked in the TriLock holes of the plate. The plate holding and positioning instrument facilitates positioning, moving and holding the implant on the bone. The plate holding and positioning instrument can be used with all TriLock 2.8 or 3.5 plate holes.



A-2950
2.8/3.5 Plate Holding and Positioning Instrument

Bending

If required, the TriLock foot plates can be bent with the plate bending pliers.

Depending on the associated system size of the plate, there are two different plate bending pliers:

Type 1 for 2.8 TriLock plates

2.0–2.8 plate bending pliers with pins (A-2047)



A-2047
2.0–2.8 Plate Bending Pliers, with Pins

Type 2 for 3.5 TriLock plates

3.5/4.0 plate bending pliers (A-2940)

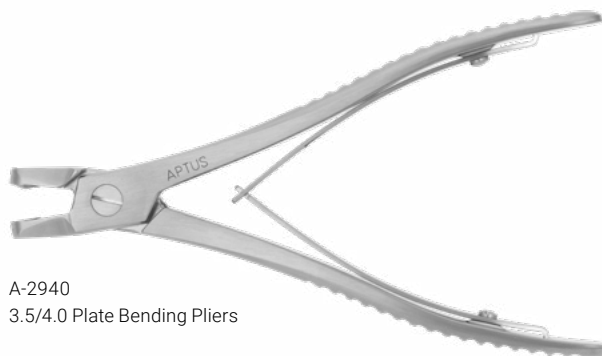

A-2940
3.5/4.0 Plate Bending Pliers

Warning

Wrong bending of the plate may lead to impaired functionality and postoperative construct failure.

The plate bending pliers are always used in pairs.

Plate bending pliers for 2.8 TriLock plates

The plate bending pliers have two different pins to protect the locking holes of flat and curved plates during the bending process. The labeled side of the plate must always face up when inserting the plate into the bending pliers (A-2047).

When bending a curved plate, the plate bending pliers must be held so that the letters “C – CURVED PLATE THIS SIDE UP” are legible from above. This ensures that the plate holes are not damaged.

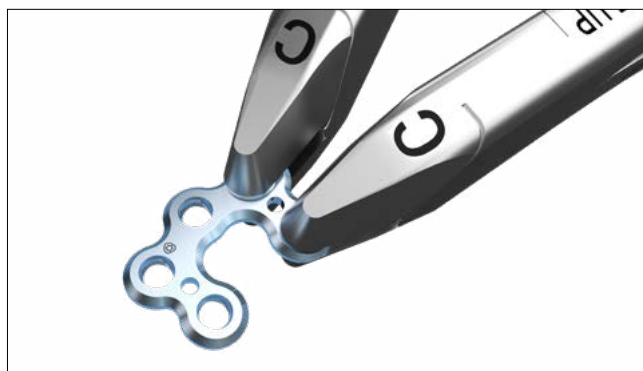

Plate bending pliers for 3.5 TriLock plates

The labeled side of the plate must always face upward when inserting the plate into the bending pliers (A-2940).

When bending plates, the plate bending pliers must be held so that the letters "UP" are legible from above. This ensures that the plate holes are not damaged.

While bending, the plate must always be held at two adjacent holes to prevent contour deformation of the intermediate plate hole.

**Warning**

Do not bend the plate by more than 30°. Bending the plate further may deform the plate holes and may cause the plate to break intra- or postoperatively.

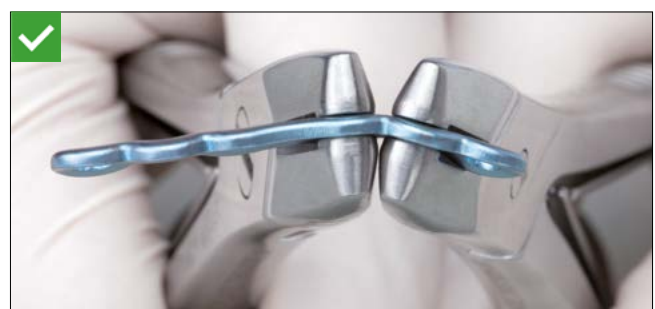
**Warning**

Repeatedly bending the plate in opposite directions may cause the plate to break postoperatively. Always use the provided plate bending pliers to avoid damaging the plate holes. Damaged plate holes prevent correct and secure seating of the screw in the plate and increase the risk of system failure.

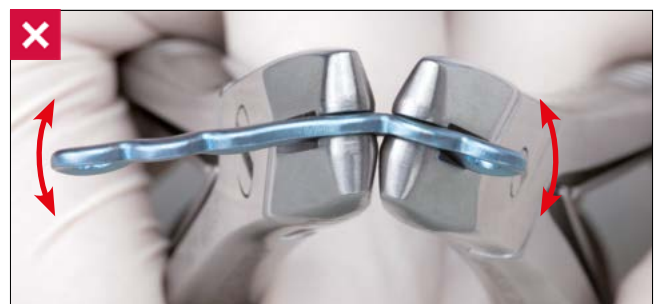

Cutting

If required, the plate cutting pliers (A-2045) can be used to cut the 2.8 and 3.5 TriLock calcaneus LCL plates (A-4850.81–84/A-4950.81–84) as well as K-wires up to a diameter of 2.0 mm.

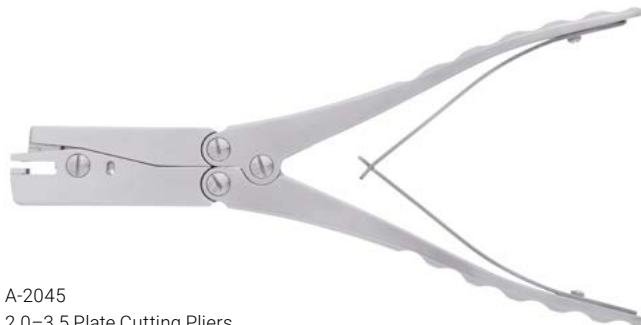

A-2045
2.0–3.5 Plate Cutting Pliers

Ensure that there are no remaining plate segments in the cutting pliers (visual check). Insert the plate from the front into the open cutting pliers. Always ensure that the labeled side of the plate is facing upwards. Hold the implantable plate segment with your hand during and after cutting.

Recommendation

To facilitate the insertion of the plate, support the cutting pliers slightly with your middle finger.



You can visually check the desired cutting line through the cutting window in the head of the pliers. Always leave enough material on the rest of the plate to keep the adjacent hole intact.

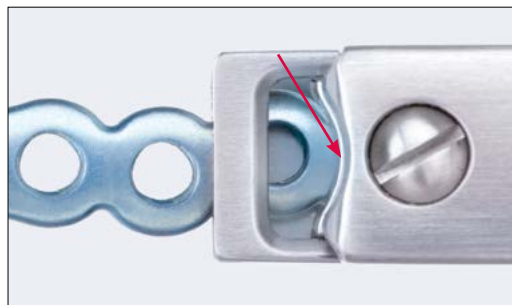

Always cut the plate holes individually. If two plate holes need to be cut off, two cutting procedures are necessary.

Warning

Wrong cutting of the plate may result in sharp edges and lead to injuries of the surrounding tissues.

Shorten the K-wires by inserting the wire through the opening located on the side of the plate cutting pliers. Cut the wire by pressing the pliers.



Drilling

Color-coded twist drills are available for every APTUS system size. All twist drills are color-coded with a ring system.

System Size	Color Code
2.8	Orange
3.5	Green

There are different types of twist drills for every system size: The core hole drill is characterized by one colored ring. The gliding hole drill (for lag screw technique) is characterized by two colored rings.

Hole Drilling for 2.8 Screws



Core hole drill with \varnothing 2.35 mm = One colored ring
A-3832



Gliding hole drill with \varnothing 2.9 mm = Two colored rings
A-3834

Hole Drilling for 3.5 Screws 3.5 Cortical and 4.0 Cancellous



Core hole drill with \varnothing 2.6 mm = One colored ring
A-3934

The twist drill \varnothing 2.6 mm (A-3934) for core holes has a golden shaft to match the golden color of the 3.5 cortical screws.

3.5 TriLock



Core hole drill with \varnothing 3.0 mm = One colored ring
A-3931



Gliding hole drill with \varnothing 3.6 mm = Two colored rings
A-3933

Warning

For 2.8 screws, the twist drill must always be guided by the drill guide (A-2820) or the self-holding drill sleeve (A-2826). This prevents damage to the screw hole and protects the surrounding tissue from direct contact with the drill. The drill guide also serves to limit the pivoting angle.



A-2820
2.8 Drill Guide



A-2826
2.5/2.8 Drill Sleeve, Self-Holding

Warning

For 3.5 screws, the twist drill must always be guided by the drill guide (A-2925 or A-2927) or the self-holding drill sleeve (A-2921). This prevents damage to the screw hole and protects the surrounding tissue from direct contact with the drill. The drill guide also serves to limit the pivoting angle.



A-2925
3.5 Drill Guide, Cortical, Drill Ø 2.6/3.6 mm

The double-ended drill guide (A-2925) can be used for LAG screw technique, 3.5 cortical and 4.0 cancellous screws.



A-2927
3.5 Drill Guide, TriLock, Drill Ø 3.0 mm

The drill guide (A-2927) is used for TriLock screws.

The self-holding drill sleeve (A-2826 for 2.8 screws and A-2921 for 3.5 screws) can be locked with a clockwise turn in the TriLock holes of the plate (no more than $\pm 15^\circ$). It thus performs all the functions of a drill guide without the need to be held.



A-2921
3.5 Drill Sleeve, Self-Holding

Warning

For TriLock plates ensure that the screw holes are predrilled with a pivoting angle of no more than $\pm 15^\circ$. For this purpose, the drill guide features a limit stop of $\pm 15^\circ$. A predrilled pivoting angle of $> 15^\circ$ no longer allows the TriLock screws to correctly lock in the plate.



A-2826
2.5 / 2.8 Drill Sleeve, Self-Holding

Assigning the Screw Length

The depth gauges (A-2837, A-2931) are used to assign the ideal screw length for use in monocortical or bicortical screw fixation.

Warning

It is important to use the correct depth gauge for the corresponding screw diameter, which is indicated on the slider and handle of the depth gauge.



A-2837
2.8 Depth Gauge



A-2931
3.5/4.0 Depth Gauge, 10-70 mm

Retract the slider of the depth gauge.

The depth gauge caliper has a hooked tip that is either inserted to the bottom of the hole or is used to catch the far cortex of the bone. When using the depth gauge, the caliper stays static, only the slider is adjusted.

To assign the screw length, place the distal end of the slider onto the implant plate or directly onto the bone (e.g. for fracture fixation with lag screws).

The ideal screw length for the assigned drill hole can be read on the scale of the depth gauge.

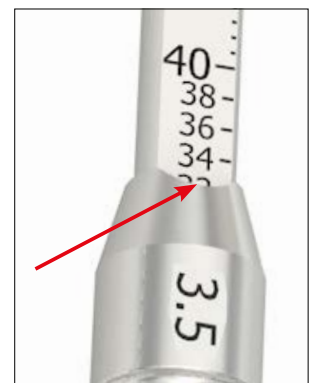
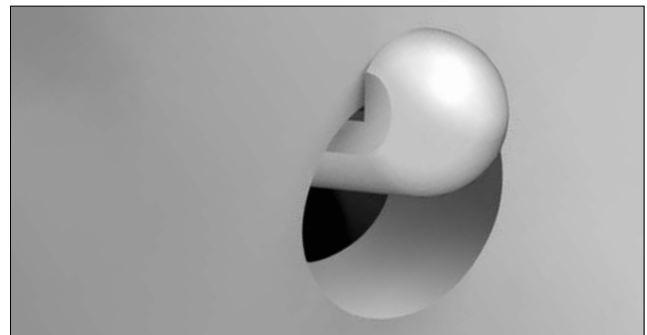

When inserting a 3.5 screw, the screw length may also be assigned directly from the scale on the twist drill \varnothing 2.6 mm (A-3934) or \varnothing 3.0 mm (A-3931) in combination with the drill guide (A-2925 or A-2927). The length is assigned from the end of the drill guide.

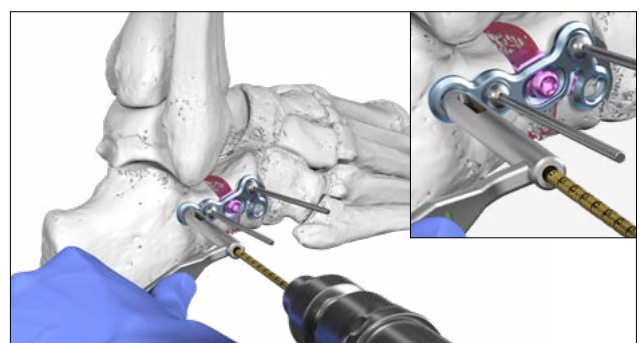

Screw Pick-Up

The screwdriver blades (A-2013, A-2911) feature the HexaDrive self-holding system.

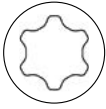

A-2013
2.5/2.8 Screwdriver Blade, HD7, AO



A-2911
3.5/4.0 Screwdriver Blade, HD15, AO

2.8 screws

For 2.8 screws, attach only the 2.5/2.8 screwdriver blade (A-2013) to the handle with quick connector (A-2073).



A-2073
Handle with Quick Connector, AO

3.5 screws

For 3.5 screws, attach only the 3.5/4.0 screwdriver blade (A-2911) to either the handle with quick connector (A-2074) or the T-handle with quick connector (A-2075).



A-2074
Handle with Quick Connector, AO

Warning

Do not use the 2.5/2.8 screwdriver blade (A-2013) with the large handle (A-2074) or with the T-handle (A-2075), as the high forces generated can damage the locking of the screw head in the plate hole.



A-2075
T-Handle with Quick Connector, AO

To remove the screws from the implant container, insert the appropriately color-coded screwdriver blade perpendicularly into the screw head of the desired screw and pick up the screw with axial pressure.

Notice

The screw will not hold without axial pressure.

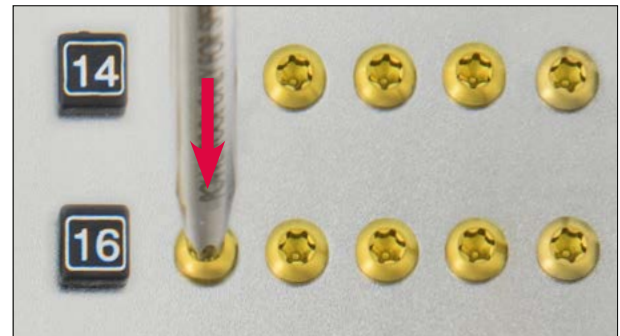

Caution

Vertically extract the screw from the compartment. Picking up the screw repeatedly may lead to permanent deformation of the self-retaining area of the HexaDrive inside the screw head. Therefore, the screw may no longer be able to be picked up correctly. In this case, a new screw has to be used.

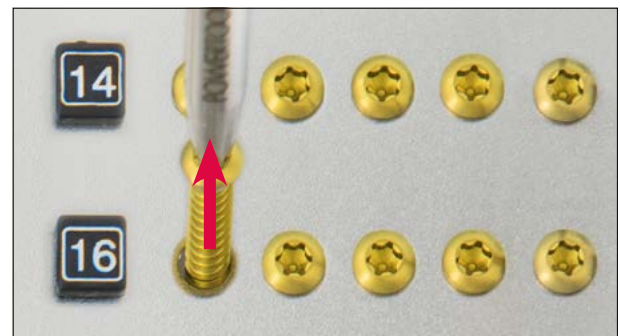

Notice

Check the screw length and diameter at the scale of the measuring module. The screw length is determined at the end of the screw head.

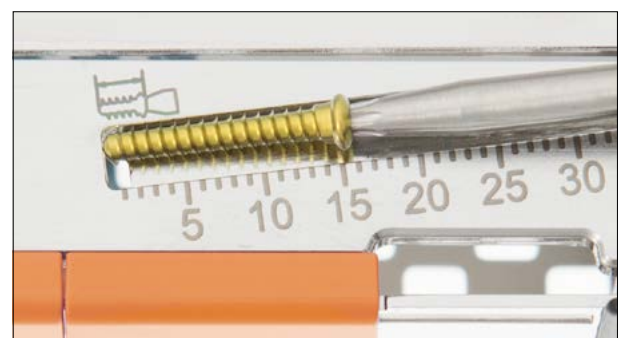

Specific Instrument Application

K-Wire Spreader for 1.6 or 2.0 mm K-Wires

To perform a distraction using the K-wire spreader for 1.6 mm or 2.0 mm K-wires, press the handles together. To keep the distraction of the osteotomy the ratchet of the spreaders can be fixed.

Warning

Overdistraction could damage the bone and/or the K-wires. If the spreader is placed too high away from the bone, the K-wires may possibly bend.

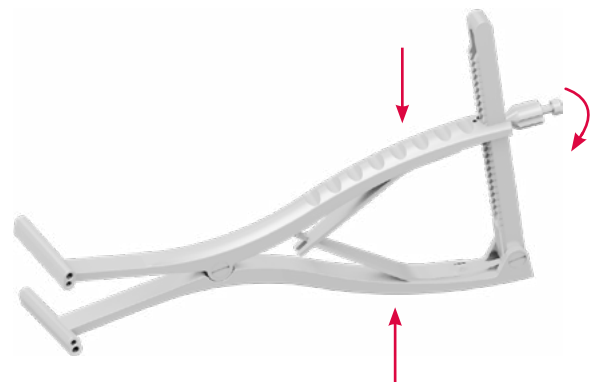

A-2056
K-Wire Spreader

Lamina Spreader

To perform a distraction using the lamina spreader, press the handles together. To keep the required distraction, the ratchet of the spreader can be fixed.

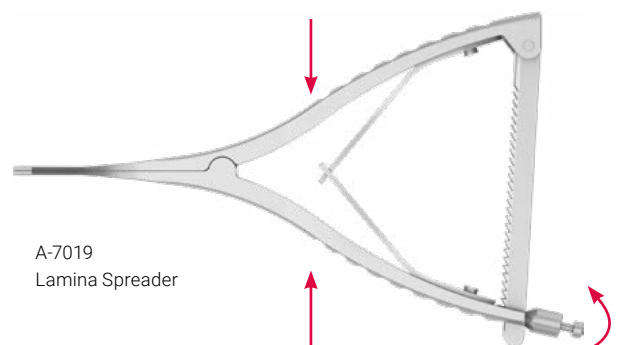

A-7019
Lamina Spreader

Surgical Techniques

General Surgical Techniques

Lag Screw Technique

The drill guides for 2.8 cortical screws (A-2820) and 3.5 cortical screws (A-2925) are used to perform the classic lag screw technique according to AO/ASIF.

Warning

Incorrect application of the lag screw technique may result in postoperative loss of reduction.

1. Drilling the gliding hole

Drill the gliding hole using the twist drill marked with two colored rings (A-3834 or A-3933) in combination with the end of the drill guide (A-2820 or A-2925) labeled with "LAG". Drill perpendicular to the fracture line.

Do not drill further than the fracture line.



A-2820
2.8 Drill Guide



A-2925
3.5 Drill Guide



Example of a 2.8 lag screw technique



Gliding hole drill with \varnothing 2.9 mm = Two colored rings
A-3834



Gliding hole drill with \varnothing 3.6 mm = Two colored rings
A-3933

2. Drilling the core hole

Place the other end of the drill guide (A-2820 or A-2925) onto the drilled gliding hole and use the twist drill for core holes with one colored ring (A-3832 or A-3934) to drill the core hole of the required screw size.



Example of a 2.8 lag screw technique



A-3832

Core hole drill with \varnothing 2.35 mm = One colored ring



A-3934

Core hole drill with \varnothing 2.6 mm = One colored ring

3. Compressing the fracture

Compress the fracture with the corresponding cortical screw (A-5800.xx or A-5901.xx).

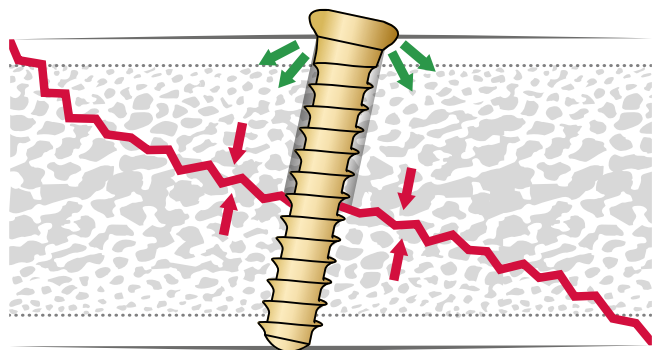

4. Optional steps before compression

If required, use the countersink (A-3835 or A-3930) to create a recess in the bone for the screw head.



Example of a recess for a 2.8 screw



A-3835
Countersink for 2.8 Cortical Screw Ø 3.7 mm



A-3930
Countersink for 3.5 Cortical Screw Ø 6.0 mm

Caution

Use the handle (A-2073 or A-2074) instead of a power tool to reduce the risk of countersinking too far through the near cortex.

Specific Surgical Techniques

Wedges Small and Large for Plates 2.8/3.5

1. Preparation

After performing the osteotomy, use the K-wire spreader (A-2056), the lamina spreader (A-7019) or the three-chisel-technique to open the osteotomy to the desired correction. To keep the distraction of the osteotomy open, fix the ratchet of the spreaders.

When performing the osteotomy, leave the lateral cortex intact to act as a hinge for the opening of the wedge.

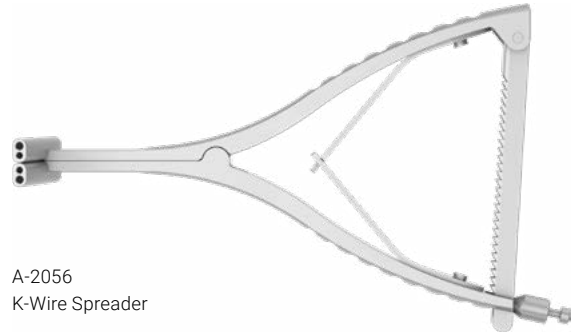

A-2056
K-Wire Spreader

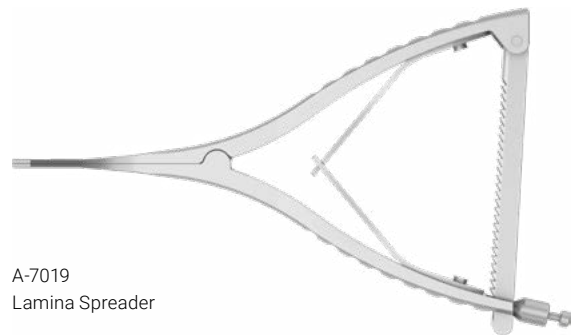

A-7019
Lamina Spreader

2. Assigning the wedge size

Insert the trial wedge (A-2006) into the open osteotomy. The scale on the trial wedge indicates the wedge width.



The end of the trial wedge marked "small" indicates the widths of the small wedges, while the end marked "large" indicates the widths of the large wedges.

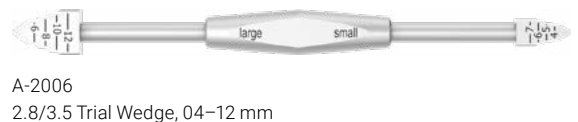

A-2006
2.8/3.5 Trial Wedge, 04-12 mm

3. Positioning the wedge

The specified wedge width corresponds to the width of the closed wedge surface.

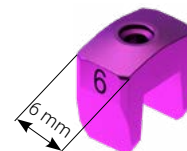

The open, u-shaped wedge surface is placed in contact with the osteotomy surfaces. The laser-marked size of the wedge on the closed surface must still be visible after wedge placement.

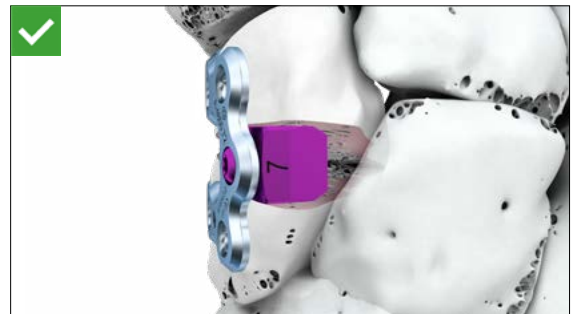

Correct position of the wedge

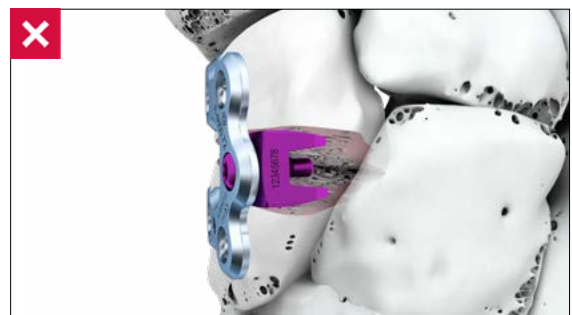

Incorrect position of the wedge

4. Mounting the wedge on the plate

Place the plate on top of the chosen wedge and remove it from the implant container by inserting the 2.8/3.5 wedge inserter (A-2005) into the threaded hole of the wedge.

The 2.8/3.5 wedge inserter can be used for insertion and positioning of the small and large wedges.

Use the wedge inserter to place the wedge in the osteotomy gap while orientating the plate into position. When the plate and the wedge are in the correct position, remove the wedge inserter and fix the wedge with the corresponding wedge screw (A-4099.01/1 or A-4099.02/1, depending on the system size of the combined plate).

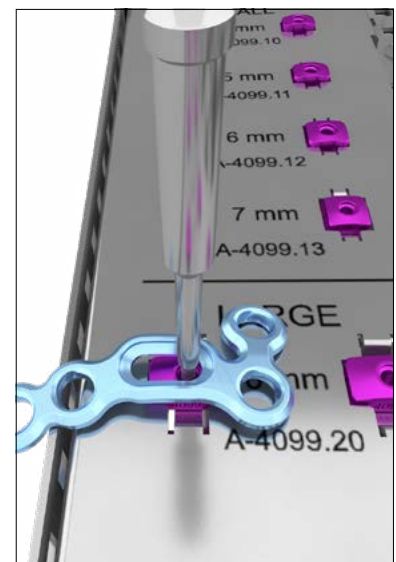

System Size	Wedge Screw	Article No.
2.8	Wedge Screw, 09 mm, HD7	A-4099.01/1
3.5	Wedge Screw, 11 mm, HD15	A-4099.02/1



A-4099.01/1



A-4099.02/1



Alternatively, the wedge can be fixed to the plate with the corresponding wedge screw before placing the wedge-plate construct into the osteotomy gap.



Warning

When positioning the plate (A-4850.72–73, A-4850.81–84, A-4950.81–84) over the osteotomy gap, two screws are to be inserted in each bone fragment.

Examples of combinations of plates and wedges

Plate	Typical Clinical Opening Wedge Osteotomies	Plate Hole to Fix the Wedge with Corresponding Wedge Screw	Possible Screw Combinations with Plate Hole
2.8 TriLock Plate, C A-4850.72–73	Cotton osteotomy		- 2.8 Wedge screws (A-4099.01/1) - 2.8 TriLock and cortical screws (A-5850.xx and 5800.xx)
2.8 TriLock Calcaneus LCL Plate A-4850.81–84	Calcaneal osteotomy (LCL)		- 2.8 Wedge screws (A-4099.01/1) - 2.8 Cortical screws (A-5800.xx)
3.5 TriLock Calcaneus LCL Plate A-4950.81–84	Calcaneal osteotomy (LCL)		- 3.5 Wedge screws (A-4099.02/1) - 3.5 Cortical screws (A-5901.xx) The 4.0 cancellous screws (A-5990.xx) with their wider diameter cannot be used in the oblong hole, only in 3.5 TriLock screw holes.

2.8 TriLock C Plate

Cotton Osteotomy Plate
(A-4850.72–73)

1. Osteotomy and distraction

Perform the osteotomy in the center of the medial cuneiform cutting the medial and lateral cortices.

When performing the osteotomy, leave the far cortex intact to act as a hinge for the opening of the wedge.

After performing the osteotomy, use the K-wire spreader (A-2056), the lamina spreader (A-7019) or the three-chisel-technique to open the osteotomy to the desired correction. To keep the distraction of the osteotomy open, fix the ratchet of the spreaders.

If a wedge is to be used in combination with the plate, refer to the technique described in “Specific Surgical Techniques – Wedges Small and Large for Plates 2.8 / 3.5”.

2. Positioning the plate

Position the plate over the osteotomy with the arms of the plate facing plantar.

3. Temporarily fixing the plate

Temporarily fix the plate on each side of the osteotomy with 1.6 mm K-wires (A-5040.41 or A-5042.41) through the K-wire holes.

4. Fixing the plate

When the plate is in the correct position, drill, assign the screw length and insert the screws, making sure all screws are angled away from the osteotomy. Remove the temporary fixation K-wires.

The choice of angular stable TriLock screws (A-5850.xx) generally provides a higher stability to the construct, especially in case of poor bone quality.

It is recommended to use the following combinations of plate and wedge size:

Plate	Recommended Wedge Size	Possible Screw Combinations with Plate Hole
2.8 TriLock Plate, C Small (A-4850.73)	4–5 mm	- 2.8 Wedge screws (A-4099.01/1) - 2.8 TriLock and cortical screws (A-5850.xx and A-5800.xx)
2.8 TriLock Plate, C Large (A-4850.72)	4–7 mm	- 2.8 Wedge screws (A-4099.01/1) - 2.8 TriLock and cortical screws (A-5850.xx and A-5800.xx)

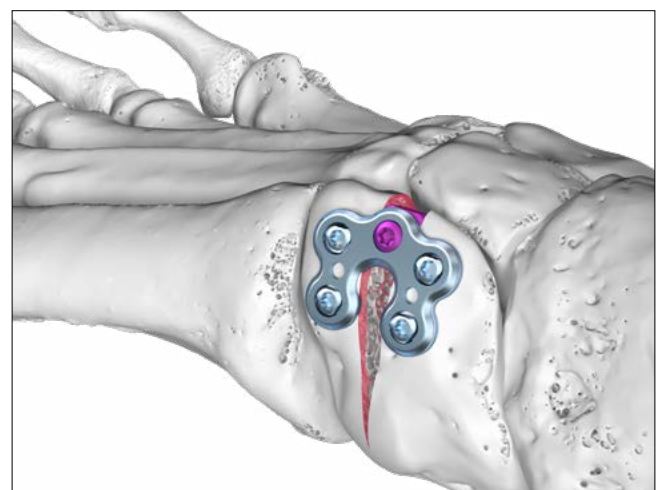
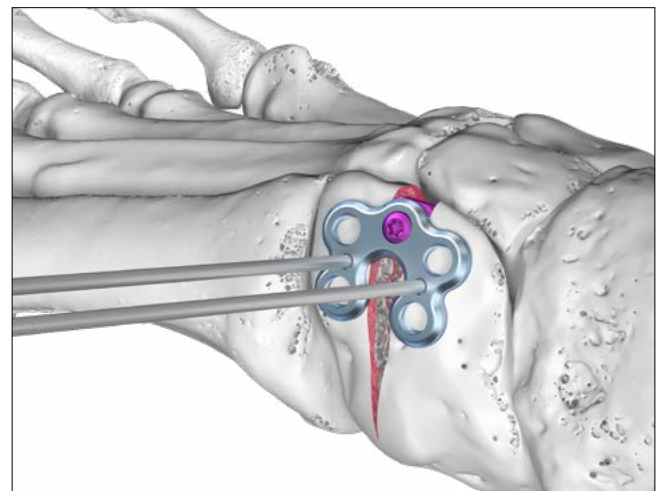

2.8 TriLock Calcaneus LCL Plates

(A-4850.81–84)

3.5 TriLock Calcaneus LCL Plates

(A-4950.81–84)

1. Osteotomy and distraction

Perform the osteotomy in the calcaneus according to the Evans procedure or the osteotomy procedure for lateral column lengthening preferred.

Use the K-wire spreader (A-2056) or the lamina spreader (A-7019) to open the osteotomy.

To keep the distraction open to the desired correction, fix the ratchet of the spreaders.

If a wedge is to be used in combination with the plate, refer to the technique described in "Specific Surgical Techniques – Wedges Small and Large for Plates 2.8/3.5".

It is recommended to use the following combinations of plate and wedge size:

Plate	Recommended Wedge Size	Possible Screw Combinations with Plate Hole
2.8 TriLock Calcaneus LCL Plate, Small (A-4850.83–84)	6–8 mm	- 2.8 Wedge screws (A-4099.01/1) - 2.8 Cortical screws (A-5800.xx)
2.8 TriLock Calcaneus LCL Plate, Large (A-4850.81–82)	6–12 mm	- 2.8 Wedge screws (A-4099.01/1) - 2.8 Cortical screws (A-5800.xx)
3.5 TriLock Calcaneus LCL Plate, Small (A-4950.83–84)	6–8 mm	- 3.5 Wedge screws (A-4099.02/1) - 3.5 Cortical screws (A-5901.xx) The 4.0 cancellous screws (A-5990.xx) with their wider diameter cannot be used in the oblong hole, only in 3.5 TriLock screw holes.
3.5 TriLock Calcaneus LCL Plate, Large (A-4950.81–82)	6–12 mm	- 3.5 Wedge screws (A-4099.02/1) - 3.5 Cortical screws (A-5901.xx) The 4.0 cancellous screws (A-5990.xx) with their wider diameter cannot be used in the oblong hole, only in 3.5 TriLock screw holes.

2. Positioning the plate

Insert the appropriate left or right version of the LCL plate as dorsally as possible.

3. Temporarily fixing the plate

1.6 mm olive K-wires (A-5045.41–42) can be inserted through the screw holes in the 2.8 calcaneus LCL plate. 2.0 mm olive K-wires (A-5045.62–63) can be inserted through the screw holes in the 3.5 calcaneus LCL plate. Estimate the appropriate thread length needed for the plate and bone combination. Insert the olive K-wire into the screw hole and slow down the insertion once the olive comes in contact with the plate.

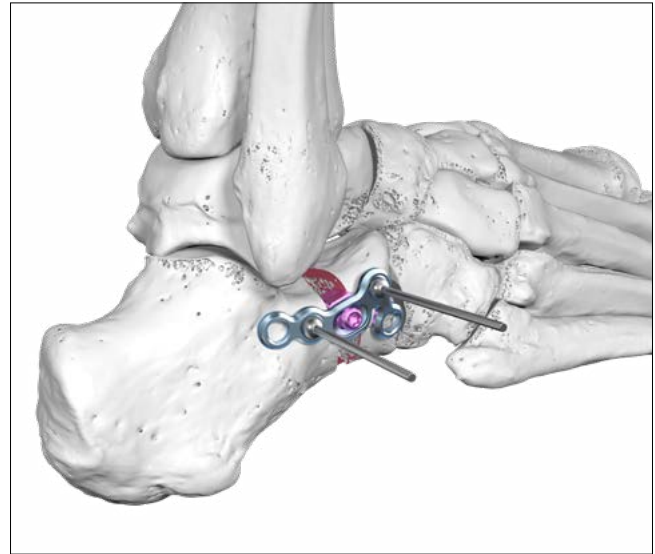

Caution

Overinsertion can lead to stripping of the bone threads and to loosening of the provisional fixation.

4. Fixing the plate

When the plate is in the correct position, drill, assign the screw length and insert the desired screw type into the free screw holes, ensuring that the screws are angled away from the osteotomy.

Remove the temporary fixation and repeat the steps above to fill the remaining screw holes.

The choice of angular stable TriLock screws (A-5850.xx or A-5950.xx) generally provides a higher stability to the construct, especially in case of poor bone quality.

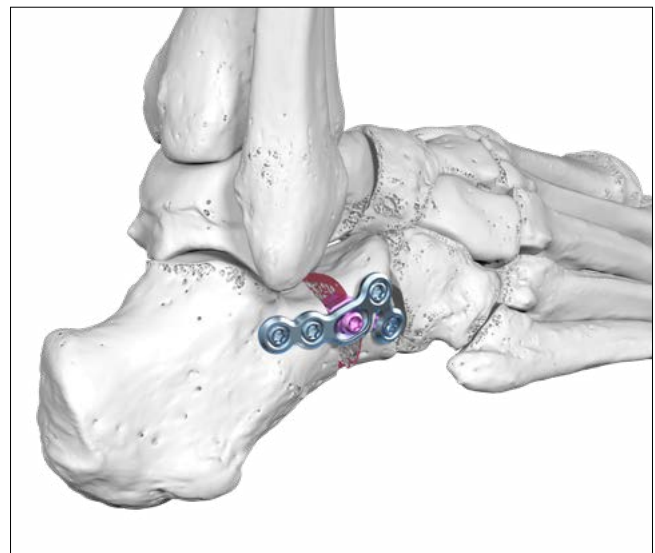

3.5 TriLock Calcaneus Step Plates

(A-4950.06/08/10/12/14)

1. Positioning the plate

Position the step plate with the correct step size (6, 8, 10, 12 or 14 mm) in the middle of the osteotomy.

In the case of a medial sliding osteotomy, the part of the plate with the three screw holes is placed anterior and the part of the plate with the two screw holes is placed posterior.

If a lateral sliding calcaneal osteotomy is performed, the plate position is reversed.

2. Temporarily fixing the plate

The plate can be temporarily fixed with a 2.0 mm K-wire (A-5040.61 or A-5042.61) or a 2.0 mm olive K-wire (A-5045.61-67) in the designated K-wire slot. The K-wire slot allows for readjustment of the step plate after the 2.0 mm K-wire or 2.0 mm olive K-wire has been inserted.

3. Fixing the plate

The calcaneal fragment can be pushed over by hand, or a cancellous screw (A-5990.xx) can be inserted in the middle screw hole to allow for the plate to be pulled to the bone.

When the plate is in the correct position, drill, assign the screw length and insert the desired screw type into the free screw holes, ensuring the screws are angled away from the osteotomy.

Warning

Insert at least two screws in each bone fragment.

Remove the temporary fixation and repeat the steps above to fill the remaining screw holes.

The choice of angular stable TriLock screws (A-5950.xx) generally provides a higher stability to the construct, especially in case of poor bone quality.

Warning

The final locking of the TriLock screws should only be performed after all the screws have been placed in the locking holes. This keeps the plate in the determined position while all the screws are being locked. The T-handle (A-2075) must always be used to lock the 3.5 TriLock screws.

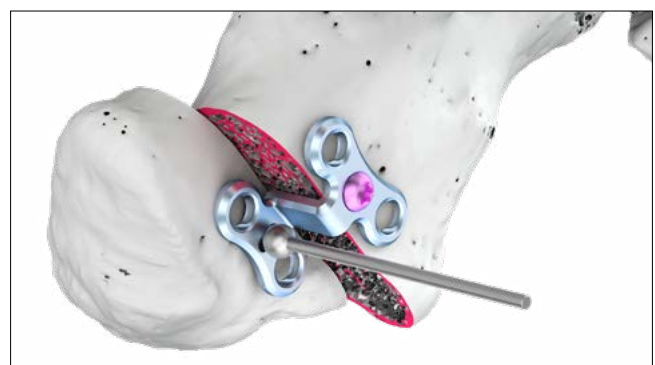
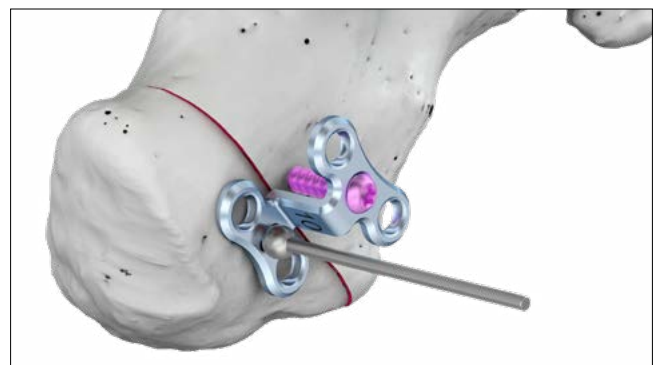

Explantation

Explantation of Mid- and Hindfoot Plates

1. Removing the screws

Unlock all screws from the plate. When all screws have been unlocked, remove them.

The order in which the screws are removed is not relevant.

In case the plate sticks to the bone, use a periosteal elevator to carefully lift and detach it from the bone.

Caution

When removing the screws, ensure that any bone ingrowth in the screw head has been removed, that the screwdriver/screw head connection is aligned in axial direction, and that a sufficient axial force is used between blade and screw.

TriLock Locking Technology

Correct Application of the TriLock Locking Technology – 2.8 TriLock Screws

The screw is inserted through the plate hole into a predrilled canal in the bone. An increase of the tightening torque will be felt as soon as the screw head gets in contact with the plate surface.

occurs (section "B" in the diagram). Finally, the actual locking is initiated (section "C" in the diagram) as a friction connection is established between screw and plate when tightening firmly.

This indicates the start of the "Insertion Phase" as the screw head starts entering the locking zone of the plate (section "A" in the diagram). Afterwards, a drop of the tightening torque

The torque applied during fastening of the screw is decisive for the quality of the locking as described in section "C" of the diagram.

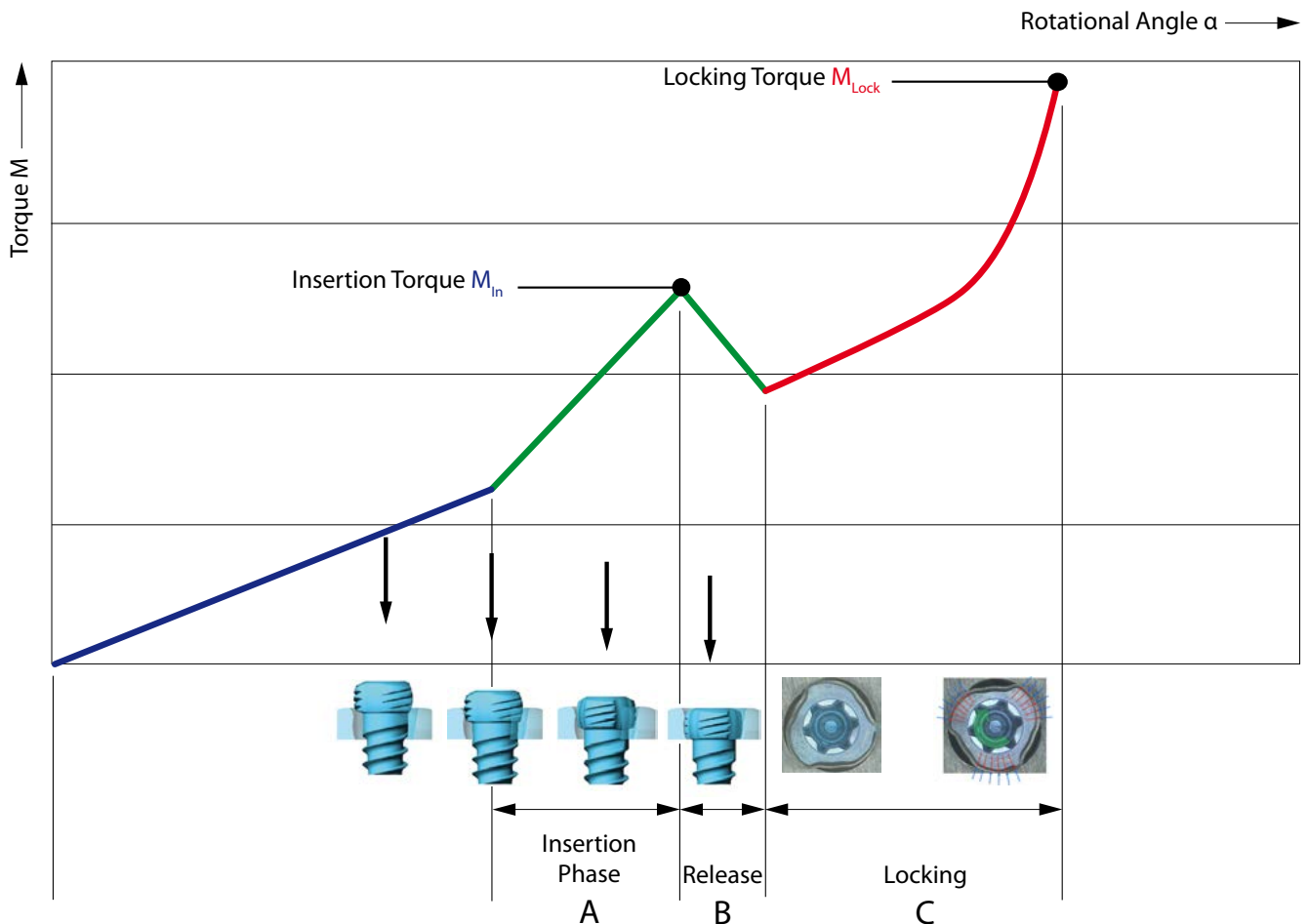

Correct Application of the TriLock Locking Technology – 3.5 TriLock Screws

The screw is inserted through the plate hole into the predrilled bone. A “contact torque” will be felt once the screw head makes contact with the plate surface; for the 3.5 TriLock screws this torque increase is easily perceived (section “A” in the diagram).

The torque then decreases before it starts increasing again during the “Insertion Phase”, as the screw head enters the locking hole (section “B” in the diagram). Once the screw head

has entered the locking hole, a second decrease of torque occurs (section “C” in the diagram). Finally, the actual locking is initiated (section “D” in the diagram) as a friction connection is established between screw and plate when tightening firmly. The torque applied in section “D” is decisive for the quality of the locking.

In summary, two intermediate torque maxima have to be overcome before there is the final locking of the screw.

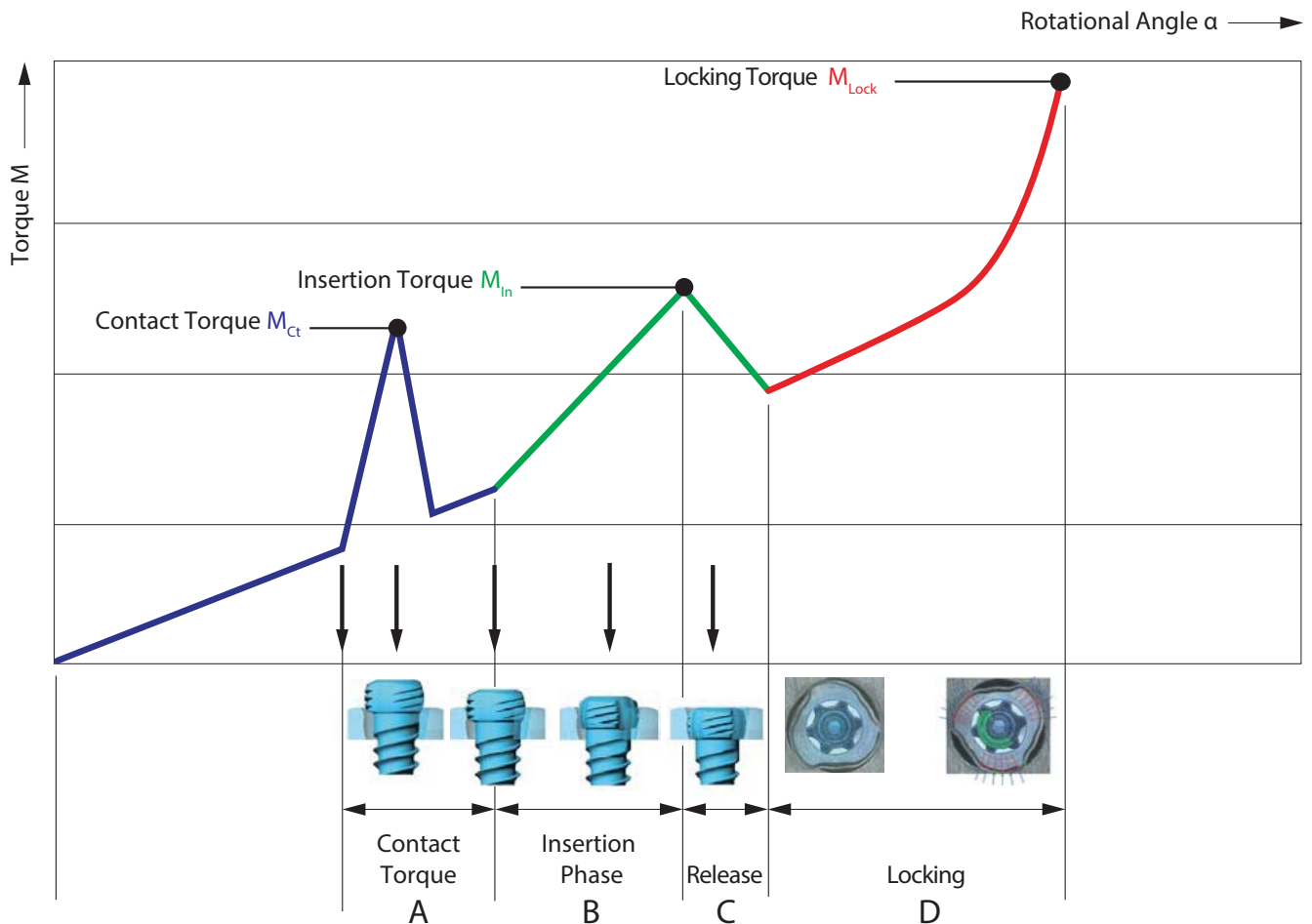

Correct Locking ($\pm 15^\circ$) of the TriLock Screws in the Mid- and Hindfoot System 2.8/3.5

The example below representatively depicts the correct locking position of a 2.5 screw in a straight 1.6 mm thick plate. Correct locking occurs only when the screw head is locked flush with the locking contour (fig. 1 and 3).

However, if there is still a noticeable protrusion (fig. 2 and 4), the screw head has not completely reached the locking position. In this case, the screw has to be retightened to obtain

full penetration and proper locking. In case of poor bone quality, a slight axial pressure may be necessary to achieve proper locking.

After having reached the locking torque (MLock), do not further tighten the screw, otherwise the locking function cannot be guaranteed anymore.

Correct: LOCKED

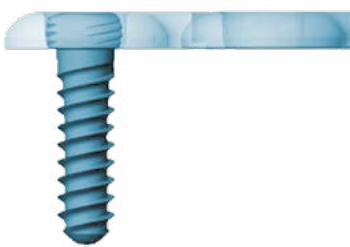

Figure 1

Incorrect: UNLOCKED

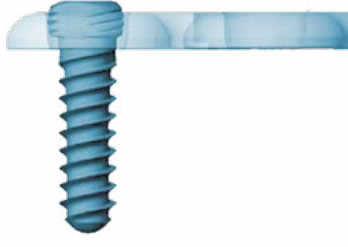

Figure 2

Correct: LOCKED

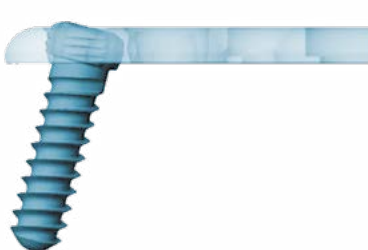

Figure 3

Incorrect: UNLOCKED



Figure 4

Implants, Instruments and Containers

2.8 Cortical Screws, HexaDrive 7

Material: Titanium alloy



Length	Art. No.	STERILE	Pieces/Pkg	Art. No.	Pieces/Pkg
8 mm	A-5800.08/1	A-5800.08/1S	1	A-5800.08	5
10 mm	A-5800.10/1	A-5800.10/1S	1	A-5800.10	5
12 mm	A-5800.12/1	A-5800.12/1S	1	A-5800.12	5
14 mm	A-5800.14/1	A-5800.14/1S	1	A-5800.14	5
16 mm	A-5800.16/1	A-5800.16/1S	1	A-5800.16	5
18 mm	A-5800.18/1	A-5800.18/1S	1	A-5800.18	5
20 mm	A-5800.20/1	A-5800.20/1S	1	A-5800.20	5
22 mm	A-5800.22/1	A-5800.22/1S	1	A-5800.22	5
24 mm	A-5800.24/1	A-5800.24/1S	1	A-5800.24	5
26 mm	A-5800.26/1	A-5800.26/1S	1	A-5800.26	5
28 mm	A-5800.28/1	A-5800.28/1S	1	A-5800.28	5
30 mm	A-5800.30/1	A-5800.30/1S	1	A-5800.30	5
32 mm	A-5800.32/1	A-5800.32/1S	1	A-5800.32	5
34 mm	A-5800.34/1	A-5800.34/1S	1	A-5800.34	5
36 mm	A-5800.36/1	A-5800.36/1S	1	A-5800.36	5
38 mm	A-5800.38/1	A-5800.38/1S	1	A-5800.38	5
40 mm	A-5800.40/1	A-5800.40/1S	1	A-5800.40	5
45 mm	A-5800.45/1	A-5800.45/1S	1	A-5800.45	5

2.8 TriLock Screws, HexaDrive 7

Material: Titanium alloy



Length	Art. No.	STERILE	Pieces/Pkg	Art. No.	Pieces/Pkg
8 mm	A-5850.08/1	A-5850.08/1S	1	A-5850.08	5
10 mm	A-5850.10/1	A-5850.10/1S	1	A-5850.10	5
12 mm	A-5850.12/1	A-5850.12/1S	1	A-5850.12	5
14 mm	A-5850.14/1	A-5850.14/1S	1	A-5850.14	5
16 mm	A-5850.16/1	A-5850.16/1S	1	A-5850.16	5
18 mm	A-5850.18/1	A-5850.18/1S	1	A-5850.18	5
20 mm	A-5850.20/1	A-5850.20/1S	1	A-5850.20	5
22 mm	A-5850.22/1	A-5850.22/1S	1	A-5850.22	5
24 mm	A-5850.24/1	A-5850.24/1S	1	A-5850.24	5
26 mm	A-5850.26/1	A-5850.26/1S	1	A-5850.26	5
28 mm	A-5850.28/1	A-5850.28/1S	1	A-5850.28	5
30 mm	A-5850.30/1	A-5850.30/1S	1	A-5850.30	5
32 mm	A-5850.32/1	A-5850.32/1S	1	A-5850.32	5
34 mm	A-5850.34/1	A-5850.34/1S	1	A-5850.34	5
36 mm	A-5850.36/1	A-5850.36/1S	1	A-5850.36	5
38 mm	A-5850.38/1	A-5850.38/1S	1	A-5850.38	5
40 mm	A-5850.40/1	A-5850.40/1S	1	A-5850.40	5
45 mm	A-5850.45/1	A-5850.45/1S	1	A-5850.45	5

3.5 Cortical Screws, HexaDrive 15

Material: Titanium alloy



Length	Art. No.	STERILE	Pieces/Pkg
10 mm	A-5901.10/1	A-5901.10/1S	1
12 mm	A-5901.12/1	A-5901.12/1S	1
14 mm	A-5901.14/1	A-5901.14/1S	1
16 mm	A-5901.16/1	A-5901.16/1S	1
18 mm	A-5901.18/1	A-5901.18/1S	1
20 mm	A-5901.20/1	A-5901.20/1S	1
22 mm	A-5901.22/1	A-5901.22/1S	1
24 mm	A-5901.24/1	A-5901.24/1S	1
26 mm	A-5901.26/1	A-5901.26/1S	1
28 mm	A-5901.28/1	A-5901.28/1S	1
30 mm	A-5901.30/1	A-5901.30/1S	1
32 mm	A-5901.32/1	A-5901.32/1S	1
34 mm	A-5901.34/1	A-5901.34/1S	1
36 mm	A-5901.36/1	A-5901.36/1S	1
38 mm	A-5901.38/1	A-5901.38/1S	1
40 mm	A-5901.40/1	A-5901.40/1S	1
45 mm	A-5901.45/1	A-5901.45/1S	1
50 mm	A-5901.50/1	A-5901.50/1S	1
55 mm	A-5901.55/1	A-5901.55/1S	1
60 mm	A-5901.60/1	A-5901.60/1S	1

3.5 TriLock Screws, HexaDrive 15

Material: Titanium alloy

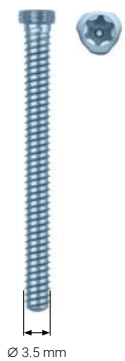

Length	Art. No.	STERILE	Pieces/Pkg
10 mm	A-5950.10/1	A-5950.10/1S	1
12 mm	A-5950.12/1	A-5950.12/1S	1
14 mm	A-5950.14/1	A-5950.14/1S	1
16 mm	A-5950.16/1	A-5950.16/1S	1
18 mm	A-5950.18/1	A-5950.18/1S	1
20 mm	A-5950.20/1	A-5950.20/1S	1
22 mm	A-5950.22/1	A-5950.22/1S	1
24 mm	A-5950.24/1	A-5950.24/1S	1
26 mm	A-5950.26/1	A-5950.26/1S	1
28 mm	A-5950.28/1	A-5950.28/1S	1
30 mm	A-5950.30/1	A-5950.30/1S	1
32 mm	A-5950.32/1	A-5950.32/1S	1
34 mm	A-5950.34/1	A-5950.34/1S	1
36 mm	A-5950.36/1	A-5950.36/1S	1
38 mm	A-5950.38/1	A-5950.38/1S	1
40 mm	A-5950.40/1	A-5950.40/1S	1
45 mm	A-5950.45/1	A-5950.45/1S	1
50 mm	A-5950.50/1	A-5950.50/1S	1
55 mm	A-5950.55/1	A-5950.55/1S	1
60 mm	A-5950.60/1	A-5950.60/1S	1

4.0 Cancellous Screws, HexaDrive 15

Material: Titanium alloy



Length	Art. No.	STERILE	Pieces/Pkg
10 mm	A-5990.10/1	A-5990.10/1S	1
12 mm	A-5990.12/1	A-5990.12/1S	1
14 mm	A-5990.14/1	A-5990.14/1S	1
16 mm	A-5990.16/1	A-5990.16/1S	1
18 mm	A-5990.18/1	A-5990.18/1S	1
20 mm	A-5990.20/1	A-5990.20/1S	1
22 mm	A-5990.22/1	A-5990.22/1S	1
24 mm	A-5990.24/1	A-5990.24/1S	1
26 mm	A-5990.26/1	A-5990.26/1S	1
28 mm	A-5990.28/1	A-5990.28/1S	1
30 mm	A-5990.30/1	A-5990.30/1S	1
32 mm	A-5990.32/1	A-5990.32/1S	1
34 mm	A-5990.34/1	A-5990.34/1S	1
36 mm	A-5990.36/1	A-5990.36/1S	1
38 mm	A-5990.38/1	A-5990.38/1S	1
40 mm	A-5990.40/1	A-5990.40/1S	1
45 mm	A-5990.45/1	A-5990.45/1S	1
50 mm	A-5990.50/1	A-5990.50/1S	1
55 mm	A-5990.55/1	A-5990.55/1S	1
60 mm	A-5990.60/1	A-5990.60/1S	1

2.8 TriLock Plates, C

Material: Unalloyed titanium
Plate thickness: 1.6 mm

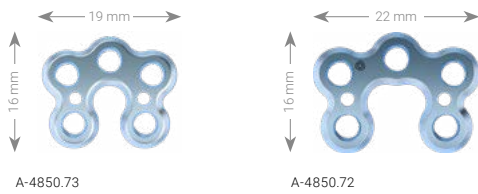

Art. No.	STERILE	Template	Description	Holes	Pieces/Pkg
A-4850.72	A-4850.72S	A-4850.72TP	large	5	1
A-4850.73	A-4850.73S	A-4850.73TP	small	5	1

2.8 TriLock Calcaneus LCL Plates

Material: Unalloyed titanium
Plate thickness: 1.6 mm

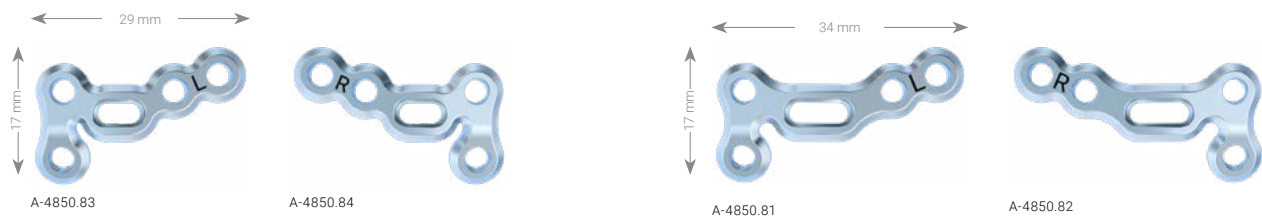

Art. No.	STERILE	Template	Description	Holes	Pieces/Pkg
A-4850.81	A-4850.81S	A-4850.81TP	large, left	5	1
A-4850.82	A-4850.82S	A-4850.82TP	large, right	5	1
A-4850.83	A-4850.83S	A-4850.83TP	small, left	5	1
A-4850.84	A-4850.84S	A-4850.84TP	small, right	5	1

3.5 TriLock Calcaneus LCL Plates

Material: Unalloyed titanium
Plate thickness: 2.0 mm

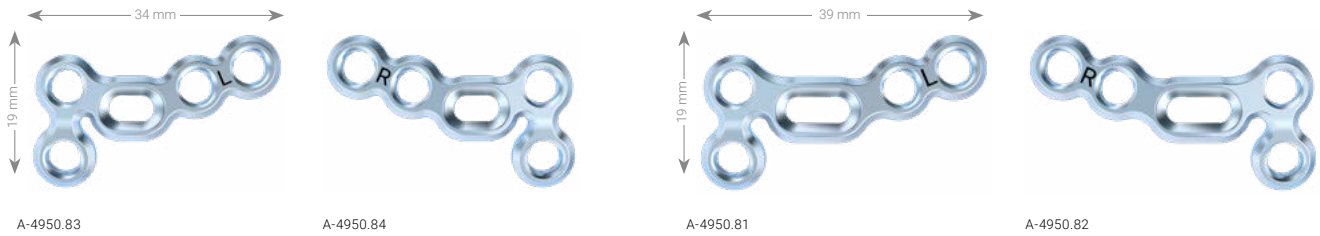

Art. No.	STERILE	Template	Description	Holes	Pieces /Pkg
A-4950.81	A-4950.81S	A-4950.81TP	large, left	5	1
A-4950.82	A-4950.82S	A-4950.82TP	large, right	5	1
A-4950.83	A-4950.83S	A-4950.83TP	small, left	5	1
A-4950.84	A-4950.84S	A-4950.84TP	small, right	5	1

3.5 TriLock Calcaneus Step Plates

Material: Unalloyed titanium
Plate thickness: 2.0 mm

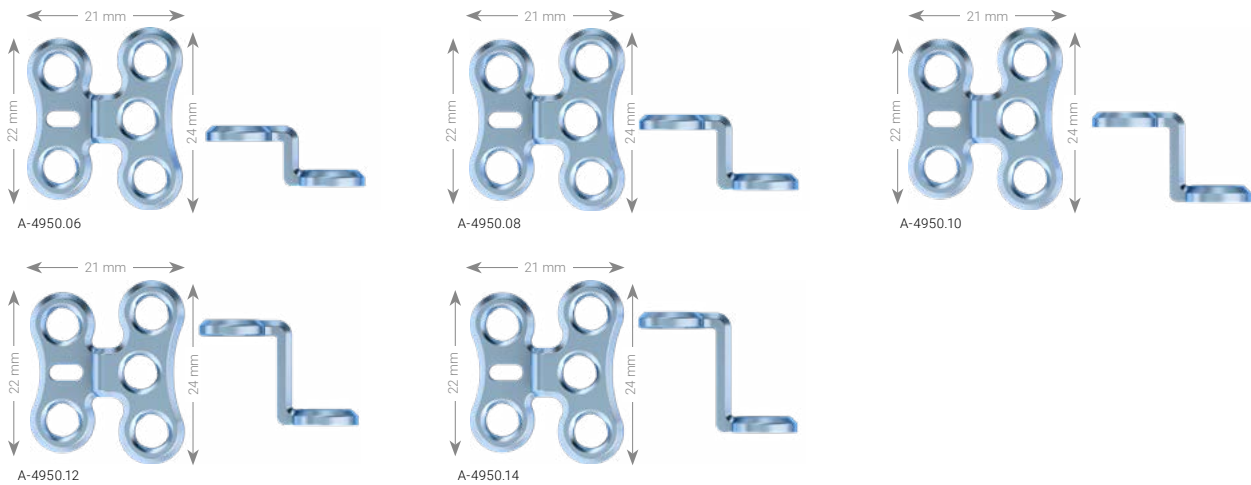

Art. No.	STERILE	Description	Holes	Pieces/Pkg
A-4950.06	A-4950.06S	step 6 mm	5	1
A-4950.08	A-4950.08S	step 8 mm	5	1
A-4950.10	A-4950.10S	step 10 mm	5	1
A-4950.12	A-4950.12S	step 12 mm	5	1
A-4950.14	A-4950.14S	step 14 mm	5	1

Wedges Small for Plates 2.8/3.5

Material: Titanium alloy

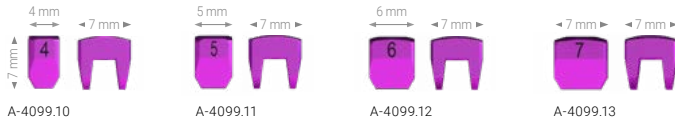

Art. No.	STERILE	Description	Pieces/Pkg
A-4099.10	A-4099.10S	4 mm	1
A-4099.11	A-4099.11S	5 mm	1
A-4099.12	A-4099.12S	6 mm	1
A-4099.13	A-4099.13S	7 mm	1

Wedges Large for Plates 2.8/3.5

Material: Titanium alloy



Art. No.	STERILE	Description	Pieces/Pkg
A-4099.20	A-4099.20S	6 mm	1
A-4099.21	A-4099.21S	8 mm	1
A-4099.22	A-4099.22S	10 mm	1
A-4099.23	A-4099.23S	12 mm	1

Wedge Screws 2.8/3.5

Material: Titanium alloy



Art. No	STERILE	System Size	Description	Length	Pieces/Pkg
A-4099.01/1	A-4099.01/1S	2.8	HD7	9 mm	1
A-4099.02/1	A-4099.02/1S	3.5	HD15	11 mm	1

Twist Drill Ø 2.35 mm



Art. No.	STERILE	System Size	Stop	Length	Shaft End	Pieces/Pkg
A-3832	A-3832S	2.8	50 mm	101 mm	AO Quick Coupling	1

Twist Drill Ø 2.9 mm (for Gliding Hole)



Art. No.	STERILE	System Size	Stop	Length	Shaft End	Pieces/Pkg
A-3834	A-3834S	2.8	10 mm	61 mm	AO Quick Coupling	1

Twist Drill Ø 2.6 mm



Art. No.	STERILE	System Size	Stop	Length	Shaft End	Pieces/Pkg
A-3934	A-3934S	3.5	70 mm	150 mm	AO Quick Coupling	1

Twist Drill Ø 3.0 mm



Art. No.	STERILE	System Size	Stop	Length	Shaft End	Pieces/Pkg
A-3931	A-3931S	3.5	70 mm	150 mm	AO Quick Coupling	1

Twist Drill Ø 3.6 mm (for Gliding Hole)



Art. No.	STERILE	System Size	Stop	Length	Shaft End	Pieces/Pkg
A-3933	A-3933S	3.5	30 mm	126 mm	AO Quick Coupling	1

Countersinks (for Cortical Screws)



A-3835



A-3930

Art. No.	STERILE	System Size	Ø	Length	Shaft End	Pieces/Pkg
A-3835	A-3835S	2.8	3.7 mm	45 mm	AO Quick Coupling	1
A-3930	A-3930S	3.5	6.0 mm	45 mm	AO Quick Coupling	1

K-Wires, Stainless Steel



Art. No.	STERILE	Ø	Description	Length	Pieces/Pkg
A-5040.41		1.6 mm	trocar	150 mm	10
A-5040.41/1		1.6 mm	trocar	150 mm	1
	A-5040.41/2S	1.6 mm	trocar	150 mm	2
A-5040.61		2.0 mm	trocar	150 mm	10
A-5040.61/1		2.0 mm	trocar	150 mm	1
	A-5040.61/2S	2.0 mm	trocar	150 mm	2
A-5042.41		1.6 mm	lancet	150 mm	10
A-5042.41/1		1.6 mm	lancet	150 mm	1
	A-5042.41/2S	1.6 mm	lancet	150 mm	2
A-5042.61		2.0 mm	lancet	150 mm	10
A-5042.61/1		2.0 mm	lancet	150 mm	1
	A-5042.61/2S	2.0 mm	lancet	150 mm	2

Olive K-Wires, No Thread, Stainless Steel

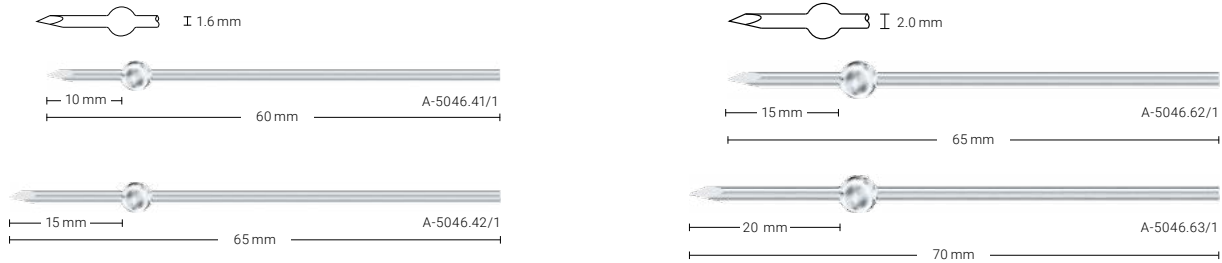

Art. No.	STERILE	∅	Tip Length (no Thread)	Length	Pieces / Pkg
A-5046.41/1		1.6 mm	10 mm	60 mm	1
	A-5046.41/2S	1.6 mm	10 mm	60 mm	2
A-5046.42/1		1.6 mm	15 mm	65 mm	1
	A-5046.42/2S	1.6 mm	15 mm	65 mm	2
A-5046.62/1		2.0 mm	15 mm	65 mm	1
	A-5046.62/2S	2.0 mm	15 mm	65 mm	2
A-5046.63/1		2.0 mm	20 mm	70 mm	1
	A-5046.63/2S	2.0 mm	20 mm	70 mm	2

Olive K-Wires, With Thread, Stainless Steel



Art. No.	STERILE	∅	Tip Length (with Thread)	Length	Pieces/Pkg
A-5045.41/1		1.6 mm	10 mm	60 mm	1
	A-5045.41/2S	1.6 mm	10 mm	60 mm	2
A-5045.42/1		1.6 mm	15 mm	65 mm	1
	A-5045.42/2S	1.6 mm	15 mm	65 mm	2
A-5045.62/1		2.0 mm	15 mm	65 mm	1
	A-5045.62/2S	2.0 mm	15 mm	65 mm	2
A-5045.63/1		2.0 mm	20 mm	70 mm	1
	A-5045.63/2S	2.0 mm	20 mm	70 mm	2

Drill Guides



Art. No.	System Size	Ø	Description	Length	Pieces / Pkg
A-2820	2.8		for cortical screws (core and gliding hole)	146 mm	1
A-2925	3.5	2.6 / 3.6	for cortical screws (core and gliding hole)	171 mm	1
A-2927	3.5	3.0	for TriLock screws	126 mm	1

Drill Sleeves



Art. No.	System Size	Description	Length	Pieces/Pkg
A-2826	2.5/2.8	self-holding	34 mm	1
A-2921	3.5	self-holding	50 mm	1

Depth Gauges



Art. No.	System Size	Description	Length	Pieces/Pkg
A-2837	2.8		189 mm	1
A-2931	3.5/4.0	10-70 mm	211 mm	1

Handles with Quick Connector



Art. No.	Description	For Shaft End	Length	Pieces/Pkg
A-2073	with twist cap	AO Quick Coupling	124 mm	1
A-2074	with twist cap	AO Quick Coupling	145 mm	1
A-2075	T-handle	AO Quick Coupling	81 mm	1

Screwdriver Blades, Self-Holding



Art. No.	System Size	Interface	Shaft End	Length	Pieces/Pkg
A-2013	2.5/2.8	HD7	AO Quick Coupling	75 mm	1
A-2911	3.5/4.0	HD15	AO Quick Coupling	80 mm	1

Plate Holding Forceps



Art. No.	System Size	Length	Pieces/Pkg
A-2050	2.0-3.5	122 mm	1

Plate Holding and Positioning Instrument



Art. No.	System Size	Length	Pieces/Pkg
A-2950	2.8/3.5	178 mm	1

Plate Cutting Pliers



Art. No.	System Size	Length	Pieces/Pkg
A-2045	2.0 - 3.5	218 mm	1

Plate Bending Pliers



A-2047



A-2940

Art. No.	System Size	Description	Length	Pieces/Pkg
A-2047	2.0 - 2.8	with pins	158 mm	1
A-2940	3.5 / 4.0		158 mm	1

Wedge Inserter



Art. No.	System Size	Length	Pieces/Pkg
A-2005	2.8 / 3.5	70 mm	1

Trial Wedge



Art. No.	System Size	Description	Length	Pieces/Pkg
A-2006	2.8 / 3.5	04 – 12 mm	167 mm	1

K-Wire Spreader

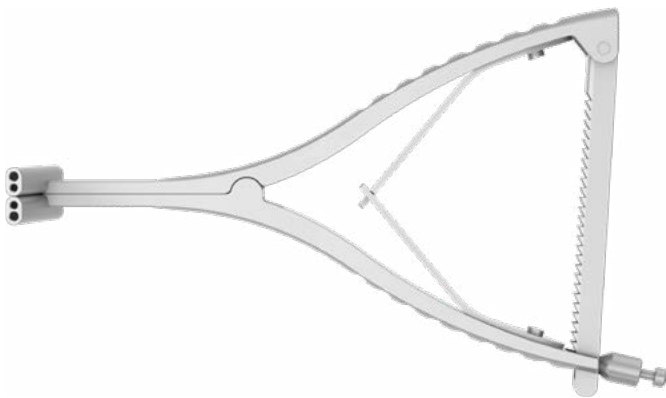

Art. No.	Description	Length	Pieces/Pkg
A-2056	for Ø 1.6 mm and 2.0 mm	175 mm	1

Lamina Spreader

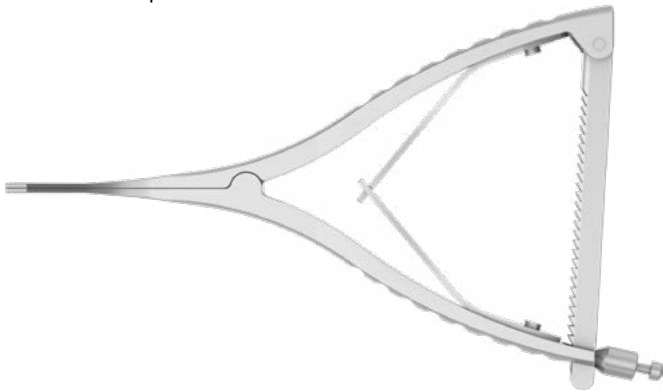

Art. No.	Length	Pieces/Pkg
A-7019	174 mm	1

Bone Elevator Mini-Hohmann



Art. No.	Width	Length	Pieces/Pkg
A-7006	8 mm	160 mm	1

Periosteal Elevator



Art. No.	Width	Length	Pieces/Pkg
A-7007	6 mm	185 mm	1

Reduction Forceps

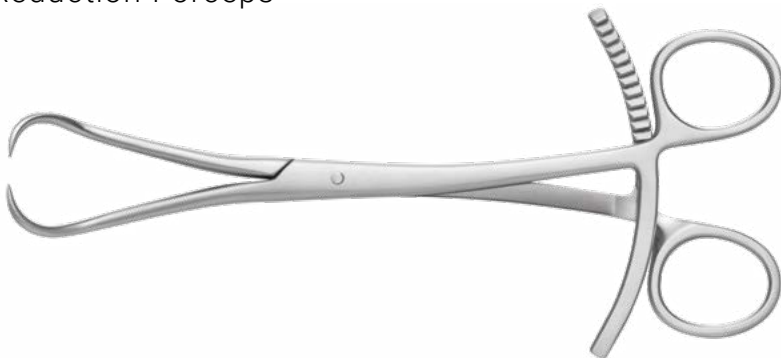

Art. No.	Length	Pieces/Pkg
A-7014	205 mm	1

Cases, Trays



A-6601.091
(excl. implants)

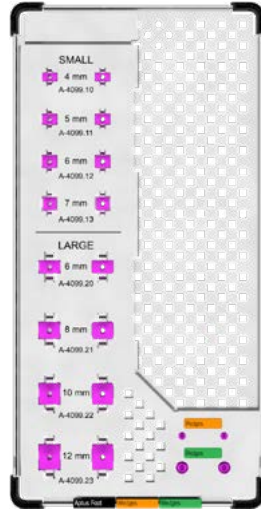

A-6601.072
(excl. implants)

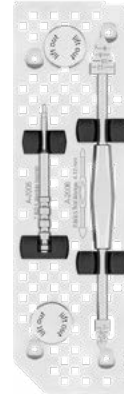

A-6601.073
(excl. instruments)

Art. No.	Description	Dimensions (W x L)	Pieces/Pkg
A-6601.072	implant case APTUS Foot wedges	120 x 240 mm	1
A-6601.073	instrument tray APTUS Foot	57 x 188 mm	1
A-6601.091	implant case APTUS Foot plates 2.8 / 3.5	120 x 240 mm	1
M-6726	lid for implant and instrument case 120 x 240 mm	120 x 240 mm	1

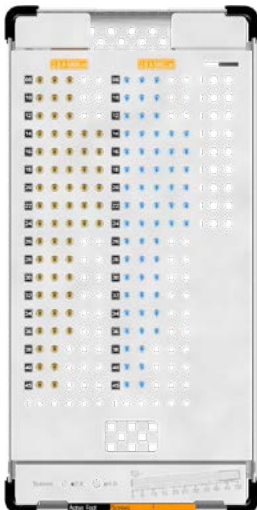

A-6601.031 with A-6601.085
(excl. screws)

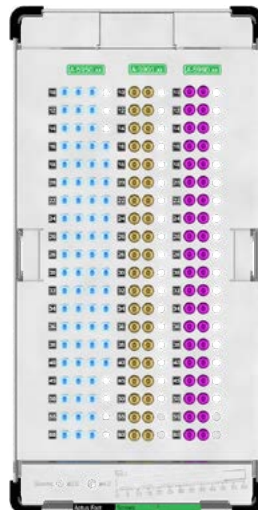

A-6601.037 with A-6601.071
(excl. screws)

Art. No.	Description	Dimensions (W x L)	Pieces/Pkg
A-6601.031	implant case APTUS Foot screws 2.8	120 x 240 mm	1
A-6601.037	implant case APTUS Foot screws 3.5 / 4.0	120 x 240 mm	1
A-6601.071	screw tray APTUS Foot 3.5	117 x 232 mm	1
A-6601.085	screw tray APTUS Foot 2.8	114 x 232 mm	1
M-6726	lid for implant and instrument case 120 x 240 mm	120 x 240 mm	1

Additional configurations available on request.

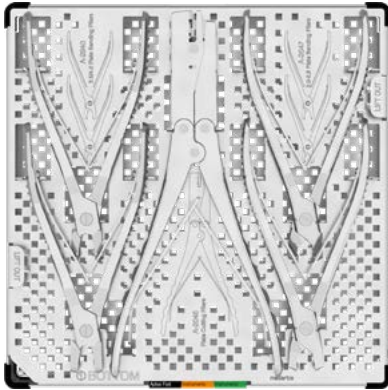

A-6601.035 with A-6601.082
(excl. instruments)

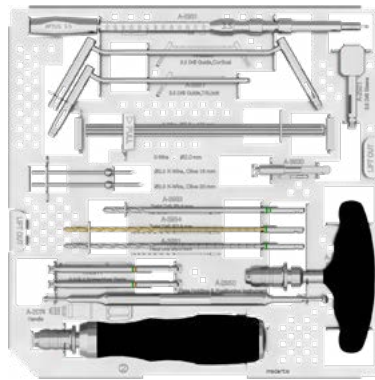

A-6601.083
(excl. instruments)

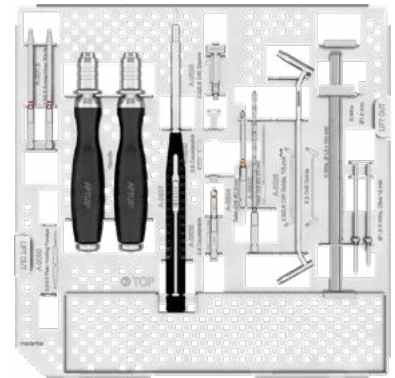

A-6601.084
(excl. instruments)



A-6601.065 with A-6601.064
(excl. instruments)



A-6601.063
(excl. instruments)

Art. No.	Description	Dimensions (W x L)	Pieces/Pkg
A-6601.035	instrument case APTUS Foot 2.8 / 3.5	240 x 240 mm	1
A-6601.063	instrument tray APTUS Foot	234 x 234 mm	1
A-6601.064	instrument tray APTUS Foot	234 x 234 mm	1
A-6601.065	instrument case APTUS Foot	240 x 240 mm	1
A-6601.082	instrument tray APTUS Foot	234 x 234 mm	1
A-6601.083	instrument tray APTUS Foot 3.5	234 x 234 mm	1
A-6601.084	instrument tray APTUS Foot 2.8	234 x 234 mm	1
M-6727	lid for implant and instrument case 240 x 240 mm	240 x 240 mm	1

Additional configurations available on request.

Storage and Transportation

Art. No.	Description	Dimensions (W x L x H)	Pieces/Pkg
M-6710	holding rack for implant and instrument cases, for case 240 x 240 mm	252 x 243 x 143 mm	1
M-6720	holding rack for implant and instrument cases, for case 240 x 240 mm	252 x 243 x 245 mm	1
M-6730	holding rack for cases, for case 2 x 240 x 240 mm	490 x 243 x 195 mm	1

Articles available on request

A-2913.1	A-6601.033
A-2913.2	A-6601.034
A-5046.43/1	A-6601.070
A-5046.43/2S	A-6601.087
A-5046.44/1	A-6601.089
A-5046.44/2S	A-6610.93
A-5046.45/1	A-6610.94
A-5046.45/2S	A-6611
A-5046.46/1	
A-5046.46/2S	
A-5046.47/1	
A-5046.47/2S	
A-5046.61/2S	
A-5046.64/2S	
A-5046.65/2S	
A-5046.66/2S	
A-5046.67/2S	
A-5800.50/1	
A-5800.55/1	
A-5800.60/1	
A-5800.50/1S	
A-5800.55/1S	
A-5800.60/1S	
A-5850.50/1	
A-5850.55/1	
A-5850.60/1	
A-5850.50/1S	
A-5850.55/1S	
A-5850.60/1S	
A-6010.16	
A-6601.030	
A-6601.032	

R FOOT-01020001_v3/2023-09, Medartis AG, Switzerland. All technical data subject to alteration.

MANUFACTURER & HEADQUARTERS

Medartis AG | Hochbergerstrasse 60E | 4057 Basel / Switzerland
P +41 61 633 34 34 | F +41 61 633 34 00 | www.medartis.com

SUBSIDIARIES

Australia | Austria | Brazil | France | Germany | Japan | Mexico | New Zealand | Poland | Spain | UK | USA

For detailed information regarding our subsidiaries and distributors, please visit www.medartis.com



Disclaimer: This information is intended to demonstrate the Medartis portfolio of medical devices. A surgeon must always rely on her or his own professional clinical judgement when deciding whether to use a particular product when treating a particular patient. Medartis is not giving any medical advice. The devices may not be available in all countries due to registration and/or medical practices. For further questions, please contact your Medartis representative (www.medartis.com). This information contains products with CE and/or UKCA marking. All pictures shown are for illustration purposes only and may not be an exact representation of the product.
For US only: Federal law restricts this device to sale by or on the order of a physician.

© Medartis 2023. Everything herein is protected by copyright, trademarks and other intellectual property rights, as applicable, owned by or licensed to Medartis or its affiliates unless otherwise indicated. It is forbidden to redistribute, duplicate or disclose anything herein, in whole or in part, without the prior written consent of Medartis.