

SURGICAL TECHNIQUE

CCS

Cannulated Compression Screws

1.7, 2.2, 3.0, 4.0, 5.0, 7.0

headedCCS

Headed Cannulated Compression Screws

2.2, 3.0, 4.0, 5.0, 7.0



Contents

| | |
|----|--|
| 3 | Introduction |
| 3 | Product Materials |
| 3 | Indications |
| 3 | Contraindications |
| 3 | Warning |
| 3 | Color Coding |
| 3 | Symbols |
| 4 | System Overview |
| 7 | Treatment Concept |
| 8 | Surgical Techniques |
| 8 | General Surgical Techniques |
| 8 | CCS 1.7, 2.2, 3.0 and headed CCS 2.2, 3.0 |
| 13 | CCS 4.0, 5.0, 7.0 and headed CCS 4.0, 5.0, 7.0 |
| 20 | Specific Surgical Techniques |
| 20 | Intramedullary Fixation |
| 21 | Click-on Parallel K-Wire Guide |
| 22 | Drill Stop |
| 24 | Protecting Soft Tissue During Screw Insertion |
| 24 | Determining Soft Tissue Thickness |
| 25 | Explanation |
| 25 | Explanation of CCS, headed CCS |
| 26 | Appendix |
| 26 | Implants, Instruments and Containers |

For further information regarding the APTUS product line visit www.medartis.com

Introduction

Product Materials

Screws and washers

Titanium alloy (ASTM F136, ISO 5832-3)

K-wires

Stainless steel (ASTM F138, ISO 5832-1)

Instruments

Stainless steel, aluminum, aluminum alloy, unalloyed titanium (ASTM F67, ISO 5832-2), Nitinol, PA, PEEK, POM, PP, PPSU, PTFE, silicone

Containers

Stainless steel, aluminum alloy, PEEK, PP, PPSU, silicone

Indications

Fractures, osteotomies and arthrodesis of bones with the appropriate screw size

Contraindications

- Preexisting or suspected infection at or near the implantation site
- Known allergies and/or hypersensitivity to implant materials
- Inferior or insufficient bone quality to securely anchor the implant
- Patients who are incapacitated and/or uncooperative during the treatment phase
- Growth plates are not to be blocked with plates and screws

Warning

- In patients with Charcot foot and/or other neuropathic diseases, the CCS and headedCCS are not to be used as stand-alone implants. They need to be used with supplemental fixation, such as additional screws and plates, across the fused joints.

Caution

- CCS and headedCCS screws have sharp threads and need to be picked up from the implant container by means of the screwdriver. Be cautious touching the screws directly.
- Screws are not to be positioned in the joint gap (exception: arthrodesis).

Color Coding

| System Size | Color Code |
|-------------|------------|
| APTUS 1.7 | Turquoise |
| APTUS 2.2 | Purple |
| APTUS 3.0 | Yellow |
| APTUS 4.0 | Brown |
| APTUS 5.0 | Dark blue |
| APTUS 7.0 | Turquoise |

Plates and Screws

Special implant plates and screws have their own color:

| | |
|---------------------|-----------------------|
| Implant screws gold | CCS and headedCCS |
| Implant plates gold | Washers for headedCCS |

Possible Combination of Plates and Screws

Plates and screws can be combined within one system size.

Symbols



















HexaDrive











System Overview

Cannulated screws and headed cannulated screws are available with short thread, long thread or fully threaded in different diameters and lengths.

| Description | Example | Main Feature | Compression | Screw Length (Increment) |
|---------------|--|---------------------|-------------|---|
| CCS 1.7 |  <p>∅ 2.2 mm ∅ 1.7 mm</p> <p>A-5281.xx</p> | Long distal thread | Yes | 8–16 mm (1 mm), 18–20 mm (2 mm) |
| |  <p>∅ 2.2 mm ∅ 1.7 mm</p> <p>A-5282.xx</p> | Fully threaded | No | 6–16 mm (1 mm) |
| CCS 2.2 |  <p>∅ 2.8 mm ∅ 2.2 mm</p> <p>A-5780.xx</p> | Short distal thread | Yes | 10–30 mm (1 mm), 32–50 mm (2 mm), 50–55 mm (5 mm) |
| |  <p>∅ 2.8 mm ∅ 2.2 mm</p> <p>A-5781.xx</p> | Long distal thread | Yes | 22–50 mm (2 mm), 50–55 mm (5 mm) |
| |  <p>∅ 2.8 mm ∅ 2.2 mm</p> <p>A-5782.xx</p> | Fully threaded | No | 10–30 mm (1 mm), 32–50 mm (2 mm), 50–55 mm (5 mm) |
| headedCCS 2.2 |  <p>∅ 3.5 mm ∅ 2.2 mm</p> <p>A-5785.xx</p> | Short distal thread | Yes | 10–30 mm (1 mm), 32–40 mm (2 mm) |
| |  <p>∅ 3.5 mm ∅ 2.2 mm</p> <p>A-5786.xx</p> | Long distal thread | Yes | 20–30 mm (1 mm), 32–40 mm (2 mm) |
| CCS 3.0 |  <p>∅ 3.8 mm ∅ 3.0 mm</p> <p>A-5880.xx</p> | Short distal thread | Yes | 10–30 mm (1 mm), 32–50 mm (2 mm), 55–70 mm (5 mm) |
| |  <p>∅ 3.8 mm ∅ 3.0 mm</p> <p>A-5881.xx</p> | Long distal thread | Yes | 26–50 mm (2 mm), 55–70 mm (5 mm) |
| |  <p>∅ 3.8 mm ∅ 3.0 mm</p> <p>A-5882.xx</p> | Fully threaded | No | 10–30 mm (1 mm), 32–50 mm (2 mm), 55–70 mm (5 mm) |

| Description | Example | Main Feature | Compression | Screw Length (Increment) |
|---------------|--|---------------------|-------------|-------------------------------------|
| headedCCS 3.0 |  <p>A-5885.xx</p> | Short distal thread | Yes | 10–30 mm (1 mm), 32–40 mm (2 mm) |
| |  <p>A-5886.xx</p> | Long distal thread | Yes | 20–30 mm (1 mm), 32–40 mm (2 mm) |
| CCS 4.0 |  <p>A-8110.xx</p> | Short distal thread | Yes | 16–50 mm (2 mm), 55–80 mm (5 mm) |
| |  <p>A-8111.xx</p> | Long distal thread | Yes | 20–50 mm (2 mm), 55–80 mm (5 mm) |
| |  <p>A-8112.xx</p> | Fully threaded | No | 16–50 mm (2 mm), 55–80 mm (5 mm) |
| headedCCS 4.0 |  <p>A-8115.xx</p> | Short distal thread | Yes | 16–50 mm (2 mm), 55–60 mm (5 mm) |
| |  <p>A-8116.xx</p> | Long distal thread | Yes | 20–50 mm (2 mm), 55–60 mm (5 mm) |
| |  <p>A-8117.xx</p> | Fully threaded | No | 16–50 mm (2 mm), 55–60 mm (5 mm) |
| CCS 5.0 |  <p>A-8210.xx</p> | Short distal thread | Yes | 24–40 mm (2 mm), 45–70 mm (5 mm) |
| |  <p>A-8211.xx</p> | Long distal thread | Yes | 30–40 mm (2 mm), 45–70 mm (5 mm) |
| |  <p>A-8212.xx</p> | Fully threaded | No | 24–40 mm (2 mm), 45–70 mm (5 mm) |

| Description | Example | Main Feature | Compression | Screw Length (Increment) |
|---------------|--|---------------------|-------------|---|
| headedCCS 5.0 |  <p>A-8215.xx</p> | Short distal thread | Yes | 24–40 mm (2 mm), 45–70 mm (5 mm) |
| |  <p>A-8216.xx</p> | Long distal thread | Yes | 30–40 mm (2 mm), 45–70 mm (5 mm) |
| |  <p>A-8217.xx</p> | Fully threaded | No | 24–40 mm (2 mm), 45–70 mm (5 mm) |
| CCS 7.0 |  <p>A-8410.xx</p> | Short distal thread | Yes | 30–110 mm (5 mm), 120–140 mm (10 mm) |
| |  <p>A-8411.xx</p> | Long distal thread | Yes | 35–110 mm (5 mm), 120–140 mm (10 mm) |
| |  <p>A-8412.xx</p> | Fully threaded | No | 30–110 mm (5 mm), 120–140 mm (10 mm) |
| headedCCS 7.0 |  <p>A-8415.xx</p> | Short distal thread | Yes | 30–110 mm (5 mm), 120–140 mm (10 mm) |
| |  <p>A-8416.xx</p> | Long distal thread | Yes | 35–110 mm (5 mm), 120–140 mm (10 mm) |
| |  <p>A-8417.xx</p> | Fully threaded | No | 30–110 mm (5 mm), 120–140 mm (10 mm) |

For the complete implant portfolio, please refer to chapter “Appendix”.

Treatment Concept

The following lists typical clinical findings which can be treated with APTUS Cannulated Compression Screws and headed Cannulated Compression Screws.

Shoulder

Fractures

- of the proximal humerus
- of the glenoid

3.0 4.0 5.0



Elbow

Fractures

- of the distal humerus
- of the proximal ulna
- of the proximal radius

2.2 3.0 4.0

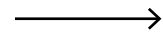

Wrist

Fractures

- of the radius
- of the ulna

Fractures and arthrodesis

- of the carpal bones

1.7 2.2 3.0 4.0



Hand

Fractures, arthrodesis and osteotomies

- of the phalanges
- of the metacarpals
- of the carpals

Knee

Fractures

- of the proximal tibia
- of the patella
- of the distal femur

4.0 5.0 7.0

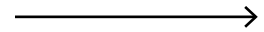

Foot and Ankle

Fractures, arthrodesis and osteotomies

- of the ankle joint
- of the subtalar joint
- of the hindfoot
- of the midfoot
- of the forefoot

2.2 3.0 4.0 5.0 7.0



The above-mentioned information is a recommendation only.

The operating surgeon is solely responsible for the choice of the suitable implant for the specific case.

Surgical Techniques

General Surgical Techniques

CCS 1.7, 2.2, 3.0 and headedCCS 2.2, 3.0

1. Selecting the K-wire

Select the required K-wire diameter depending on the screw diameter and length and verify the diameter in the container.

Caution

To ensure that the lengths of the screws to be used are assigned correctly, only original APTUS K-wires may be used. If alternative wires are used, the correct screw length selection cannot be assured.



2. Protecting the soft tissue

Position the drill guide or K-wire guide/protection sleeve with the side marked "K-WIRE" onto the bone.



CCS 1.7, 2.2, 3.0 and headedCCS 2.2, 3.0

| Art. No | For Screws | Guides / Soft Tissue Protection for |
|---------|--|---|
| A-2225 | CCS 1.7 | K-wire Drill Countersink Screw |
| A-2725 | CCS 2.2 | K-wire Drill |
| A-2825 | CCS 3.0 | K-wire Drill |
| A-2039 | CCS 2.2 CCS 3.0 | Screw |
| A-2824 | CCS 2.2 CCS 3.0 headedCCS 2.2 headedCCS 3.0 | K-wire Drill Countersink Screw |
| A-2007 | CCS 2.2 CCS 3.0 headedCCS 2.2 headedCCS 3.0 | K-wire, percutaneous |
| A-2008 | CCS 2.2 CCS 3.0 CCS 4.0 | K-wire, percutaneous |
| A-2009 | CCS 2.2 CCS 3.0 CCS 4.0 | K-wire Drill |

3. Placing the K-wire

Place the K-wire perpendicularly to the fracture or osteotomy line. Do not forcefully insert the K-wire as it may bend.

Warning

The correct position and direction of the K-wire always has to be verified using X-ray control to ensure that the K-wire is not bent.

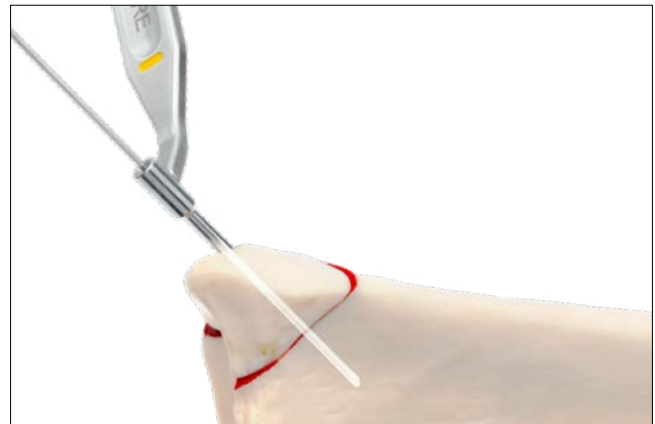

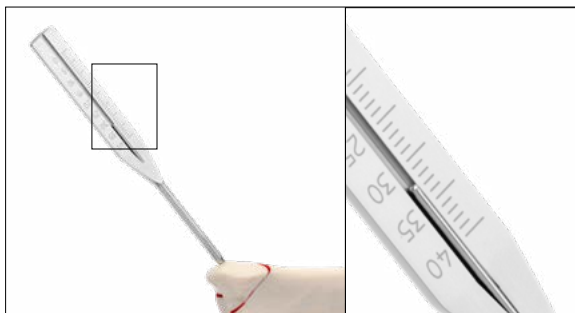
CCS 1.7, 2.2, 3.0**4. Determining the required screw length**

Remove the drill guide resp. K-wire guide/protection sleeve. Slide the depth gauge (A-2035, A-2235, A-2835) over the K-wire until it touches the bone. The length can be read from the end of the K-wire.

5A. Drilling – optional

The screw can be implanted directly without predrilling.

Caution

In the case of particularly hard bone it is mandatory to predrill over the length of the screw. This prevents the risk of the screw running up against very hard bone structure and at worst breaking. For intramedullary fixation, see chapter "Intramedullary Fixation".



Use the color-coded cannulated twist drill (A-3236, A-3736, A-3836, A-3840).

The twist drill must always be guided by a drill guide (A-2725, A-2825) or a K-wire guide/protection sleeve (A-2009, A-2225, A-2824). This protects the surrounding tissue from direct contact with the drill. Position the drill guide or the K-wire guide/protection sleeve with the side marked "DRILL" or "INSTRUMENTS" onto the bone.

Caution

Do not drill beyond the tip of the K-wire, as the K-wire will no longer have purchase in the bone.

5B. Countersinking – optional**Caution**

Use the color-coded countersink (A-3932, A-3937, A-3938) to predrill the near cortex.

headedCCS 2.2, 3.0**4A. Drilling – optional**

The screw can be implanted directly without predrilling.

Caution

In the case of particularly hard bone it is mandatory to predrill over the length of the screw. This prevents the risk of the screw running up against very hard bone structure and at worst breaking.

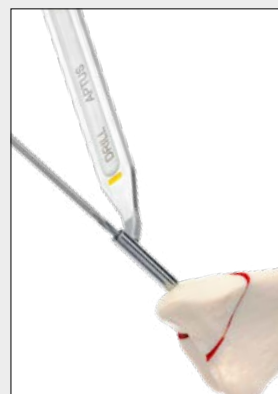

Use the color-coded cannulated twist drill (A-3736, A-3836, A-3840).

The twist drill must always be guided by a K-wire guide/protection sleeve (A-2824). This protects the surrounding tissue from direct contact with the drill. Position the K-wire guide/protection sleeve with the side marked "DRILL" or "INSTRUMENTS" onto the bone.

Caution

Do not drill beyond the tip of the K-wire, as the K-wire will no longer have purchase in the bone.

4B. Countersinking – optional**Caution**

Use the color-coded countersink (A-3935, A-3936) to predrill the near cortex.

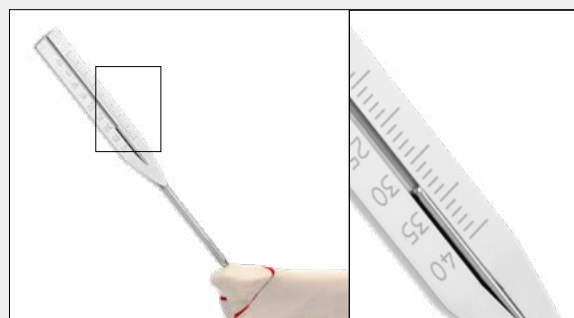
5. Determining the required screw length

The K-wire guide/protection sleeve can be left in place. Slide the depth gauge (A-2835) over the K-wire until it touches the bone. The length can be read from the end of the K-wire.

CCS 1.7, 2.2, 3.0 and headedCCS 2.2, 3.0

6. Selecting the screw

Select a screw that is slightly shorter than the length determined in Step 4 (for CCS) or Step 5 (for headedCCS) to allow for shortening through compression of the fracture gap.

Warning

When selecting the screw, it is mandatory that the distal thread is not positioned within the fracture gap, as otherwise no compression can be achieved.

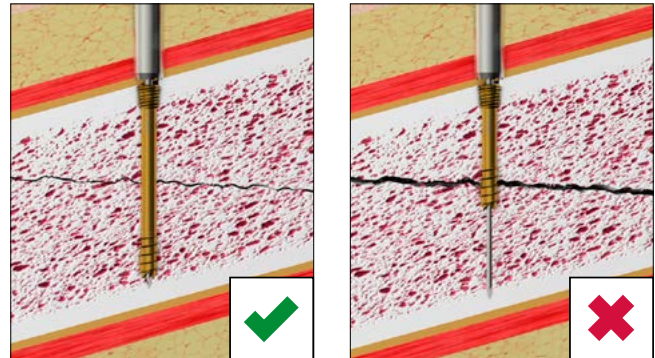

Fully threaded screws

As these screws do not compress, the thread can be positioned after reduction within the fracture gap. If compression of the fracture gap is desired, then a partially threaded screw has to be inserted first. Only afterwards a fully threaded screw may be inserted for stabilization.

7. Picking up the screw

Caution

CCS and headedCCS have sharp threads and need to be picked up from the implant container by means of the screwdriver. Be cautious touching the screws directly.

To remove the screws from the implant container, insert the appropriately color-coded screwdriver blade perpendicularly into the screw head of the desired screw and pick up the screw with axial pressure.

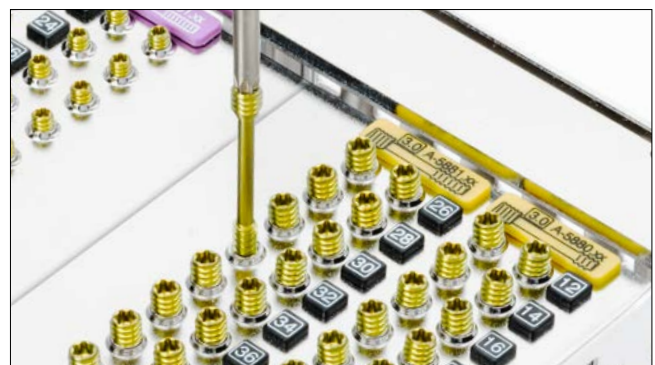

Notice

The screw will not hold without axial pressure.

Caution

Vertically extract the screw from the compartment. Picking up the screw repeatedly may lead to permanent deformation of the self-retaining area of the HexaDrive inside the screw head. Therefore, the screw may no longer be able to be picked up correctly. In this case, a new screw has to be used.



Check the screw length and diameter at the scale of the measuring module. The screw length is determined at the end of the screw head.



CCS 1.7, 2.2, 3.0 and headedCCS 2.2, 3.0

8A. Inserting the screw

Caution

CCS and headedCCS have sharp threads. Be cautious touching the screws directly.

CCS 2.2, 3.0:

Remove the drill guide (A-2009, A-2725, A-2825).

CCS 1.7, 2.2, 3.0 and headedCCS 2.2, 3.0:

The K-wire guide/protection sleeve (A-2225, A-2824) can be left in place.

headedCCS 2.2, 3.0:

Optionally, a washer (A-4700.71, A-4800.70) can also be used to achieve a larger contact surface between screw head and bone.

When inserting the screw, apply sufficient axial pressure in order to allow for proper cutting and good thread forming.

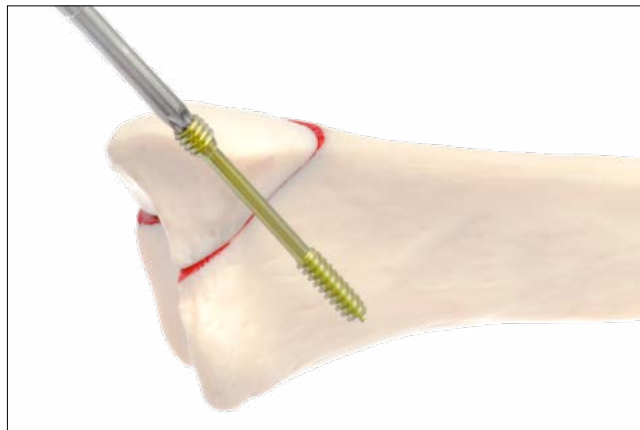

8B. Sinking the screw head

CCS 1.7, 2.2, 3.0:

Caution

Turn the screw until the screw head is completely inserted into the bone.

Remove the K-wire.

Warning

The correct position of the screw, screw head and screw tip as well as the screw length always have to be verified using X-ray control.



CCS 4.0, 5.0, 7.0 and headedCCS 4.0, 5.0, 7.0

1. Selecting the K-wire

Select the required K-wire diameter depending on screw size and verify the diameter in the container's measuring module.

Caution

To ensure that the lengths of the screws to be used are assigned correctly, only original APTUS K-wires may be used. If alternative wires are used, the correct screw length selection cannot be assured.



2. Protecting the soft tissue

Connect the color-coded protection sleeve (A-8004.23, A-8000.23, A-8001.23) to the cannulated handle with quick coupling AO or AO Large (A-2077, A-8000.20, A-8001.10).



CCS 4.0, headedCCS 4.0

CCS 5.0, headedCCS 5.0

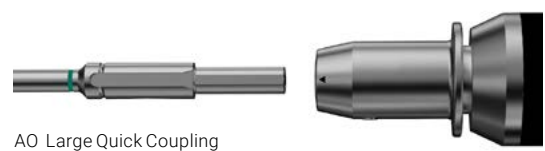

CCS 7.0, headedCCS 7.0

CCS 4.0, 5.0, 7.0 and headedCCS 4.0, 5.0, 7.0

Slide the K-wire guide (A-8004.25, A-8000.25, A-8001.25) and the trocar (A-8004.24, A-8000.24, A-8001.24) into the protection sleeve.

Place the protection sleeve onto the bone.

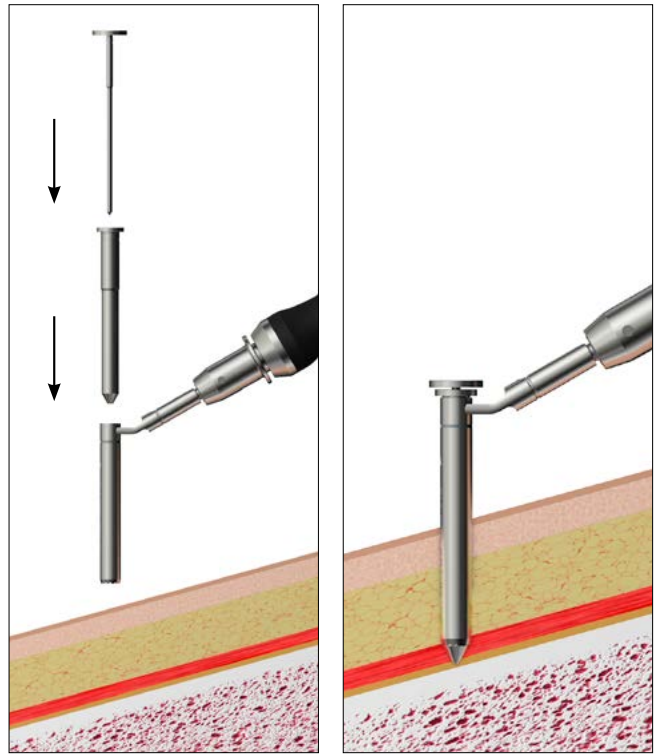

In case the trocar (A-8004.24, A-8000.24, A-8001.24) was used, pull it off with a slight turning and pulling movement.

In case the K-wire guide (A-8004.25, A-8000.25, A-8001.25) loosens, it needs to be moved back.

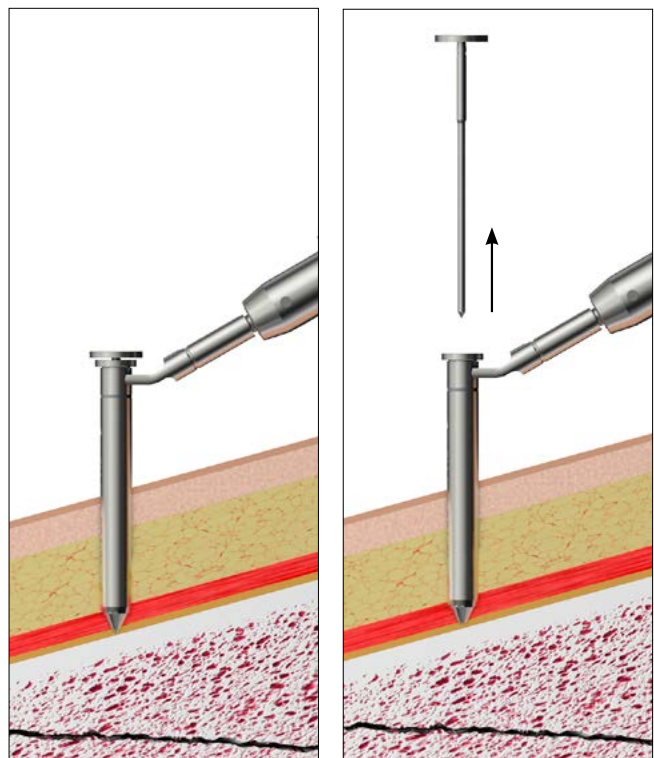

CCS 4.0, 5.0, 7.0 and headedCCS 4.0, 5.0, 7.0

3. Placing the K-wire

Place the K-wire perpendicularly to the fracture or osteotomy line. Do not forcefully insert the guide wire as it may bend.

Warning

The correct position and direction of the K-wire always has to be verified using X-ray control to ensure that the K-wire is not bent.

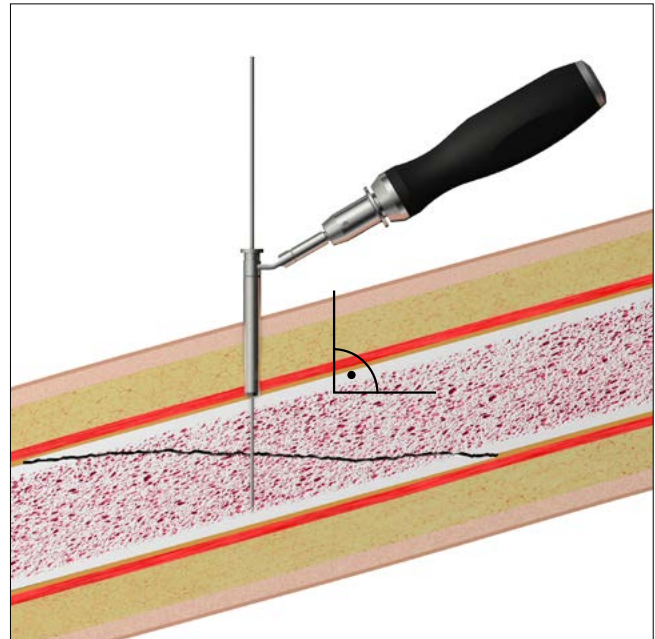

CCS 4.0, 5.0, 7.0

4. Determining the required screw length

Remove the K-wire guide (A-8004.25, A-8000.25, A-8001.25).
Slide the depth gauge (A-8004.27, A-8004.28, A-8000.27, A-8001.27) over the K-wire until it touches the bone. The length can be read from the end of the K-wire.



5A. Drilling – optional

Predrill with the color-coded twist drill (A-8004.01, A-8000.03, A-8001.01) over the K-wire through the protection sleeve.

Caution

In the case of particularly hard bone it is mandatory to predrill over the length of the screw. This prevents the risk of the screw running up against very hard bone structure and at worst breaking. For intramedullary fixation, see chapter "Intramedullary Fixation".

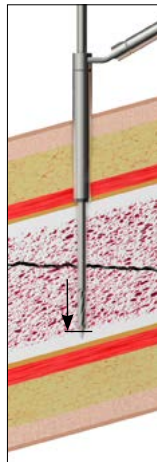

The twist drill must always be guided by a protection sleeve. This protects the surrounding tissue from direct contact with the drill.

Caution

Do not drill beyond the tip of the K-wire, as the K-wire will no longer have purchase in the bone.

5B. Countersinking – optional

Drill the first cortex with the color-coded countersink (A-8004.02, A-8000.04, A-8001.02) over the K-wire through the protection sleeve.

Caution

The use of countersinks is recommended in the case of particularly hard bone.

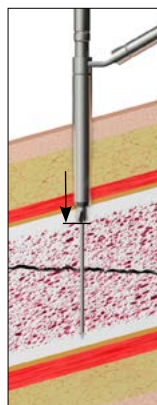

headedCCS 4.0, 5.0, 7.0

4A. Drilling – optional

Remove the K-wire guide (A-8004.25, A-8000.25, A-8001.25).
Predrill with the color-coded twist drill (A-8004.01, A-8000.03, A-8001.01) over the K-wire through the protection sleeve.

The twist drill must always be guided by a protection sleeve. This protects the surrounding tissue from direct contact with the drill.

Caution

Do not drill beyond the tip of the K-wire, as the K-wire will no longer have purchase in the bone.

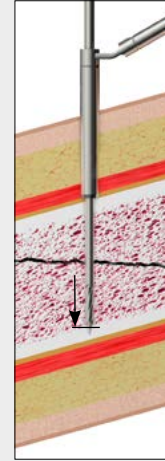

4B. Countersinking – optional

Drill the first cortex with the color-coded countersink (A-8004.03, A-8000.05, A-8001.03) over the K-wire through the protection sleeve.

Caution

The use of twist drills and/or countersinks is recommended in the case of particularly hard bone.

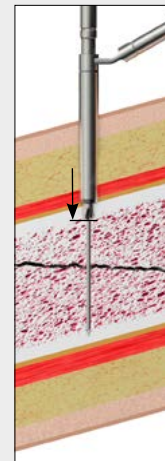

5. Determining the required screw length

Slide the depth gauge (A-8004.27, A-8004.28, A-8000.27, A-8001.27) over the K-wire until it touches the bone. The length can be read from the end of the K-wire.



CCS 4.0, 5.0, 7.0 and headedCCS 4.0, 5.0, 7.0

6. Selecting the screw

Select a screw that is slightly shorter than the length determined in Step 4 (for CCS) and Step 5 (for headedCCS) to allow for shortening of the fracture gap through compression.

Warning

When selecting the screw, it is essential that the distal thread is not positioned within the fracture gap, as otherwise no compression can be achieved.

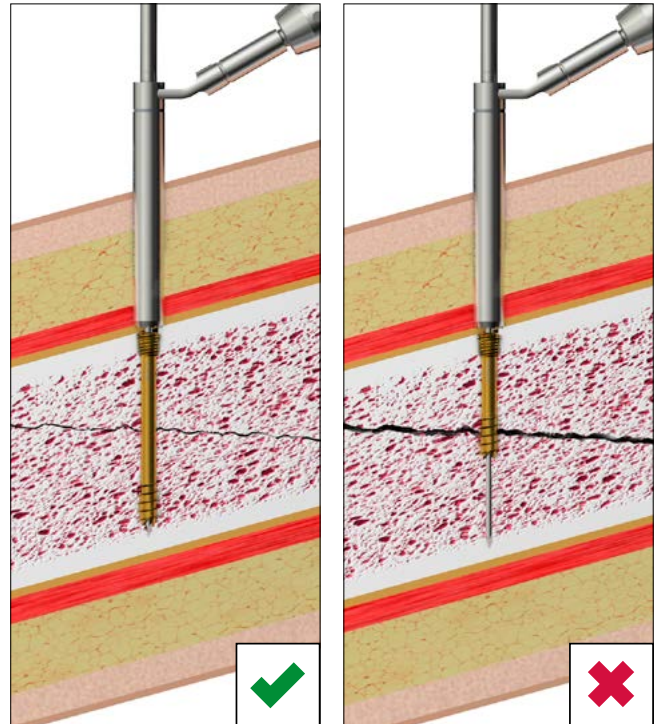

Fully threaded screws

As these screws do not compress, the thread can be positioned after reduction within the fracture gap. If compression of the fracture gap is desired, then a partially threaded screw has to be inserted first. Only afterwards a fully threaded screw may be inserted for stabilization.

CCS 4.0, 5.0, 7.0 and headedCCS 4.0, 5.0, 7.0

7. Picking up the screw

Caution

CCS and headedCCS have sharp threads and need to be picked up from the implant container by means of the screwdriver. Be cautious touching the screws directly.

To remove the screws from the implant container, insert the appropriately color-coded screwdriver blade perpendicularly into the screw head of the desired screw and pick up the screw with axial pressure.

Notice

The screw will not hold without axial pressure.

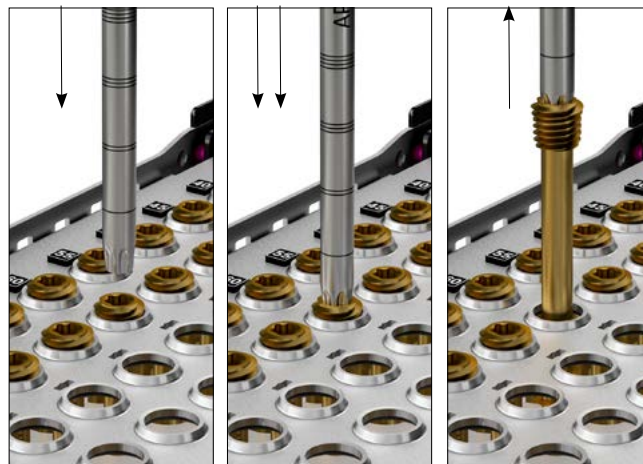

Caution

Vertically extract the screw from the compartment. Picking up the screw repeatedly may lead to permanent deformation of the self-retaining area of the HexaDrive inside the screw head. Therefore, the screw may no longer be able to be picked up correctly. In this case, a new screw has to be used.

Check the screw length and diameter at the scale of the measuring module. The screw length is determined at the end of the screw head.

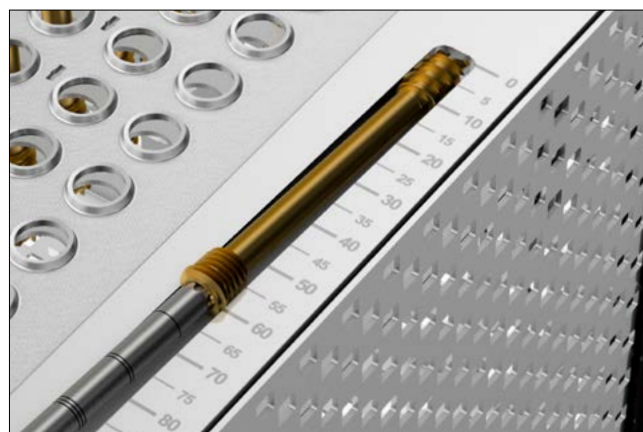

8A. Inserting the screw

Caution

CCS and headedCCS have sharp threads. Be cautious touching the screws directly.

headedCCS 4.0, 5.0, 7.0:

Optionally, a washer (A-8140.70, A-8240.70, A-8440.70) can also be used to achieve a larger contact surface between screw head and bone.

Warning

Use the protection sleeve while inserting the screws.

When inserting the screw, apply sufficient axial pressure in order to allow for proper cutting and good thread forming.

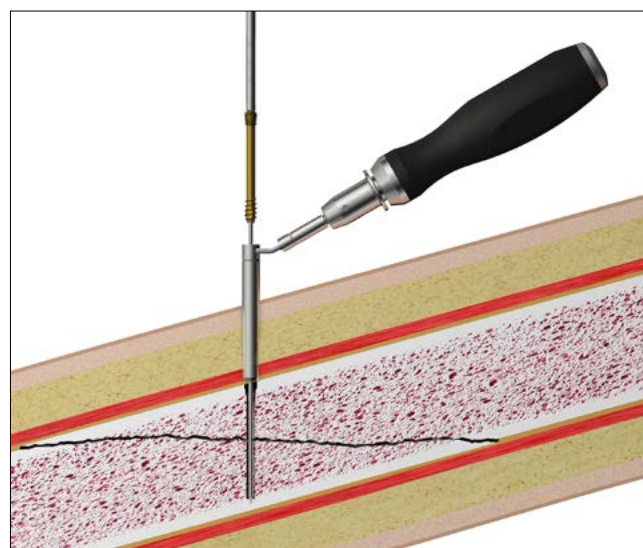

CCS 4.0, 5.0, 7.0 and headedCCS 4.0, 5.0, 7.0

8B. Sinking the screw head

CCS 4.0, 5.0, 7.0

Turn the screw until the screw head is completely inserted in the bone.

Remove the K-wire.

Warning

The correct position of the screw, screw head and screw tip as well as the screw length always have to be verified using X-ray control.

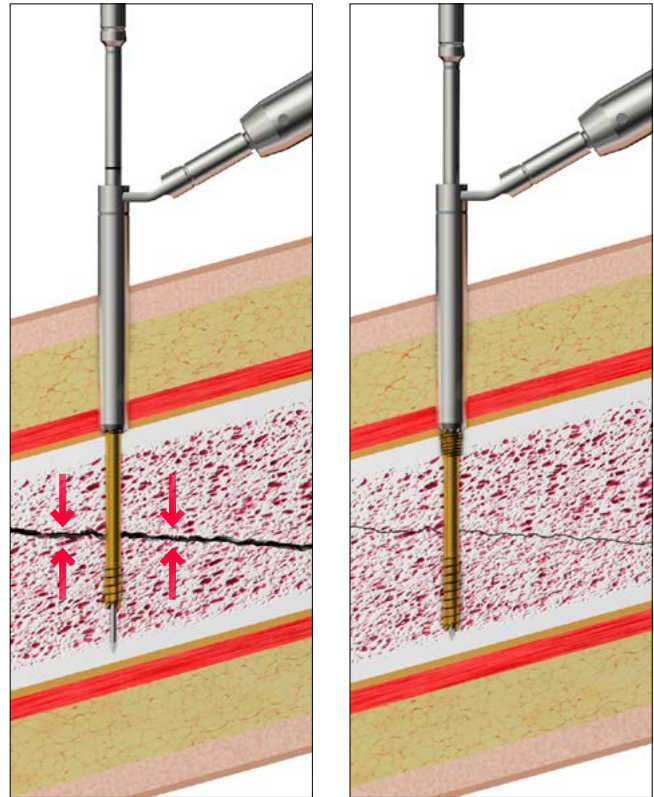

Specific Surgical Techniques

Intramedullary Fixation

1. Determining the required screw diameter

Use the 2.2/3.0 depth gauge, isthmus (A-2035), or the 4.0 depth gauge, isthmus (A-8004.28), in two different planes under X-ray control to determine the appropriate screw diameter. The diameters of the balls on the tip of the depth gauges correspond with the screw's thread diameters 2.2, 3.0 and 4.0 mm.



A-2035
2.2/3.0 Depth Gauge, L 100/150 mm, Isthmus

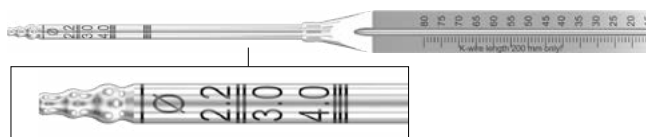

A-8004.28
4.0 Depth Gauge, Isthmus

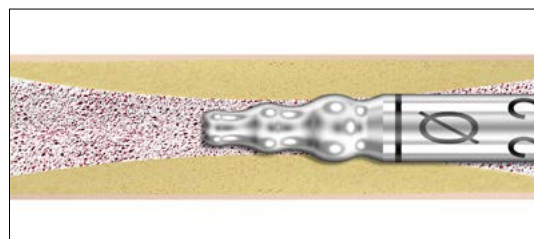

Warning

The correct position and direction of the K-wire always has to be verified using X-ray control to ensure that the K-wire is not bent.

2. Drilling – Mandatory

For intramedullary fixation, predrilling only over the full length of the isthmus is mandatory when the diameter of the screw selected is equal or bigger than the inner diameter of the isthmus.

Specific intramedullary drills corresponding to each screw diameter are to be used. These drills are marked with a wide black laser ring and "IM" on the shaft to indicate exclusively intramedullary use.

Caution

The corresponding "IM" drill (A-3741, A-3841, A-8004.04) has to be used to avoid the risk of screw breakage. Do not use the intramedullary drills for other indications. Due to bigger diameters, it might lead to poor retention of the screw.

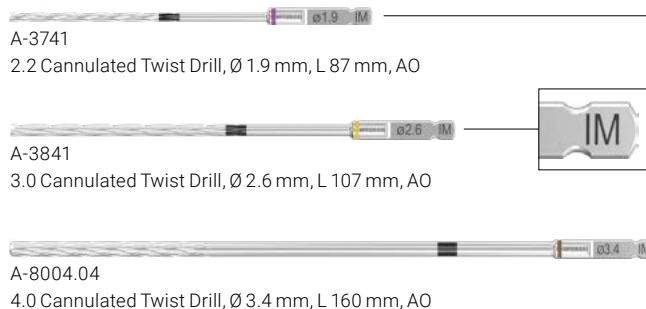

Click-On Parallel K-Wire Guide

CCS 2.2, 3.0

The click-on parallel K-wire guide (A-2027) can be used to either place two screws for rotational stable treatment of a fracture or to place a second parallel K-wire for intraoperative rotational stability.

1. Placing the K-wire

Place the first K-wire so that a second K-wire can be placed (see Step 3 on page 9 in General Surgical Techniques for CCS 1.7, 2.2, 3.0 and headedCCS 2.2, 3.0).



2. Attaching the click-on parallel K-wire guide

Attach the click-on parallel K-wire guide (A-2027) to the side marked "K-WIRE" of the drill guide (A-2009, A-2725, A-2825). Depending on the shape of the bone, the long side of the click-on guide can either be turned up or down.



3A. Placing over the K-wire

Place the click-on parallel K-wire guide (A-2027) over the K-wire which is already placed. The second K-wire can then be positioned through the drill guide (A-2009, A-2725, A-2825).

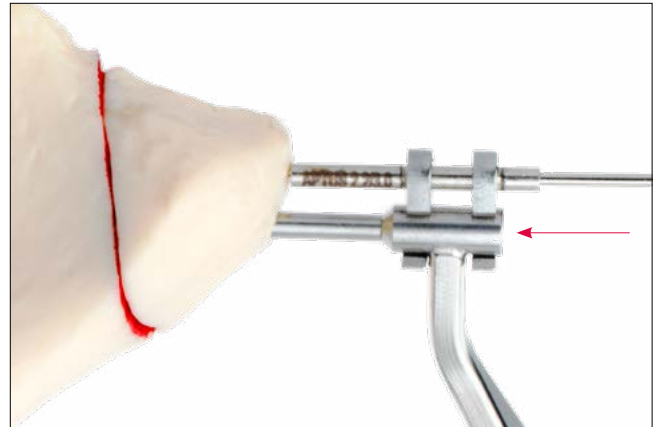

3B. Checking the K-wire position

Use X-ray control to verify the correct position of the K-wire.

4. Determining the required screw length

Continue with Step 4 on page 10 in General Surgical Techniques for CCS 1.7, 2.2, 3.0.

Caution

The click-on parallel K-wire guide must be removed parallel from the drill guide. If the guide is turned off, the click connection may distort.



Drill Stop



CCS 2.2, 3.0



The drill stop (A-2038) can be used to drill to the determined or requested drill depth.

Caution

The drill stop is only to be used together with the corresponding cannulated twist drills (A-3738 and A-3838).

1. Attaching the drill stop

Slide the drill stop (A-2038) onto the drill. The drill stop has a pictogram on both of its ends:  and .

Please make sure that  is mounted towards the scale and  towards the tip of the drill.



2. Adjusting to the drill depth

Adjust the drill stop (A-2038) to the determined or the requested drill depth and tighten it securely. The depth can be read at the end of the drill stop.

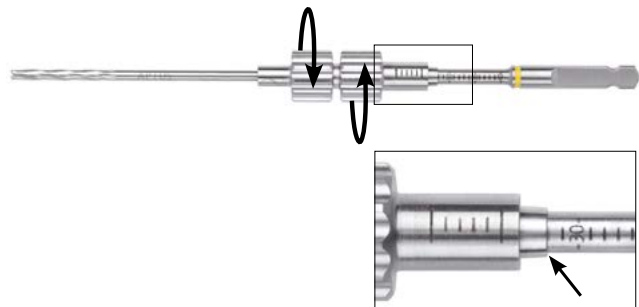

3. Drilling

Slide the drill guide and the drill over the K-wire and onto the bone. Use the side of the drill guide that is labeled with "DRILL".

The drill depth equals exactly the adjusted depth of the drill stop.

Caution

If the drill guide (A-2009, A-2725, A-2825) is not used, the hole will be drilled too deep.

If excessive axial pressure is applied, the drill stop may move on the drill.

Do not drill beyond the tip of the K-wire, as the K-wire will no longer have purchase in the bone. Therefore, the drill depth should be chosen accordingly (e.g. slightly shorter).



4. Selecting the screw

Continue with Step 6 on page 11 in General Surgical Techniques for CCS 1.7, 2.2, 3.0 and headedCCS 2.0, 3.0.

Protecting Soft Tissue During Screw Insertion

CCS 2.2, 3.0

If required, the 2.2/3.0 protection sleeve (A-2039) can be used to protect the surrounding soft tissue.
Slide the protection sleeve onto the screwdriver blade.

Put the screw onto the screwdriver.

Slide the protection sleeve to the bone.
During screw insertion the protection sleeve slides back.

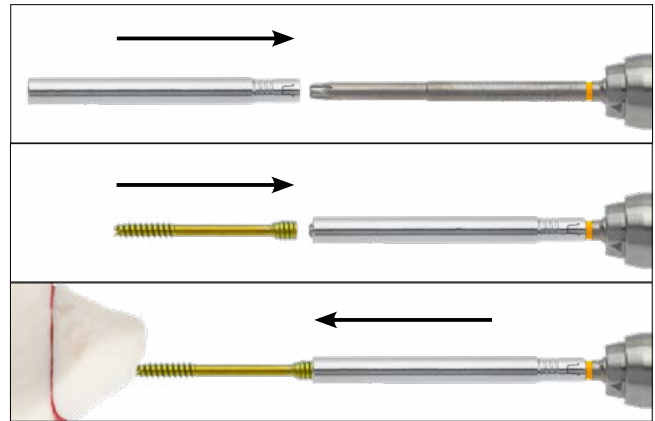

Determining Soft Tissue Thickness

CCS 4.0, 5.0, 7.0 and headedCCS 4.0, 5.0, 7.0

Caution

The depth gauge shows four laser-marked ring groups in the tip area for a rough estimate of the position relative to the soft tissue thickness when used **without** a protection sleeve.



Caution

The blade shows one single laser-marked ring in the shaft area for a rough orientation of the insertion depth relative to the soft tissue thickness when used **with** a protection sleeve.
If the screw is completely inserted, this single ring is approximately positioned at the level of the end of the protection sleeve.

In addition, the blade – like the depth gauge (A-8004.27, A-8004.28, A-8000.27, A-8001.27) – shows four laser-marked ring groups in the tip area for a rough orientation of the insertion depth relative to the soft tissue thickness when used **without** a protection sleeve. If the screw is inserted in the soft tissue to the previously determined depth gauge's ring group, the screw head is approximately positioned at the level of the cortex.

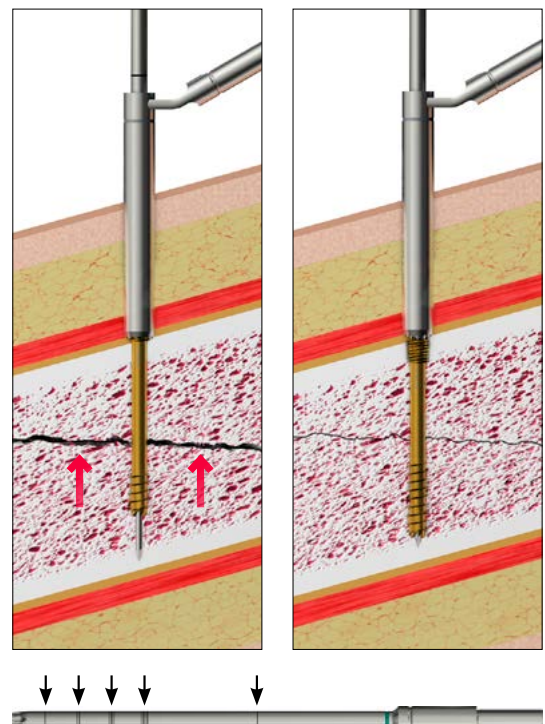

Explantation

Explantation of CCS, headedCCS

It is recommended to insert a K-wire into the screw cannulation.

Caution

When removing the screws, ensure that any bone ingrowth in the screw head has been removed, that the screwdriver/screw head connection is aligned in axial direction and that a sufficient axial force is used between blade and screw.

Appendix

Implants, Instruments and Containers

| Screws | | | | | |
|---------------|--------------|--------------|--------------|--------------|--------------|
| A-5281.08/1 | A-5282.14/1 | A-5780.25/1S | A-5781.28/1 | A-5782.16/1S | A-5782.42/1 |
| A-5281.08/1S | A-5282.14/1S | A-5780.26/1 | A-5781.28/1S | A-5782.17/1 | A-5782.42/1S |
| A-5281.09/1 | A-5282.15/1 | A-5780.26/1S | A-5781.30/1 | A-5782.17/1S | A-5782.44/1 |
| A-5281.09/1S | A-5282.15/1S | A-5780.27/1 | A-5781.30/1S | A-5782.18/1 | A-5782.44/1S |
| A-5281.10/1 | A-5282.16/1 | A-5780.27/1S | A-5781.32/1 | A-5782.18/1S | A-5782.46/1 |
| A-5281.10/1S | A-5282.16/1S | A-5780.28/1 | A-5781.32/1S | A-5782.19/1 | A-5782.46/1S |
| A-5281.11/1 | A-5780.10/1 | A-5780.28/1S | A-5781.34/1 | A-5782.19/1S | A-5782.48/1 |
| A-5281.11/1S | A-5780.10/1S | A-5780.29/1 | A-5781.34/1S | A-5782.20/1 | A-5782.48/1S |
| A-5281.12/1 | A-5780.11/1 | A-5780.29/1S | A-5781.36/1 | A-5782.20/1S | A-5782.50/1 |
| A-5281.12/1S | A-5780.11/1S | A-5780.30/1 | A-5781.36/1S | A-5782.21/1 | A-5782.50/1S |
| A-5281.13/1 | A-5780.12/1 | A-5780.30/1S | A-5781.38/1 | A-5782.21/1S | A-5782.55/1 |
| A-5281.13/1S | A-5780.12/1S | A-5780.32/1 | A-5781.38/1S | A-5782.22/1 | A-5782.55/1S |
| A-5281.14/1 | A-5780.13/1 | A-5780.32/1S | A-5781.40/1 | A-5782.22/1S | A-5785.10/1 |
| A-5281.14/1S | A-5780.13/1S | A-5780.34/1 | A-5781.40/1S | A-5782.23/1 | A-5785.10/1S |
| A-5281.15/1 | A-5780.14/1 | A-5780.34/1S | A-5781.42/1 | A-5782.23/1S | A-5785.11/1 |
| A-5281.15/1S | A-5780.14/1S | A-5780.36/1 | A-5781.42/1S | A-5782.24/1 | A-5785.11/1S |
| A-5281.16/1 | A-5780.15/1 | A-5780.36/1S | A-5781.44/1 | A-5782.24/1S | A-5785.12/1 |
| A-5281.16/1S | A-5780.15/1S | A-5780.38/1 | A-5781.44/1S | A-5782.25/1 | A-5785.12/1S |
| A-5281.18/1 | A-5780.16/1 | A-5780.38/1S | A-5781.46/1 | A-5782.25/1S | A-5785.13/1 |
| A-5281.18/1S | A-5780.16/1S | A-5780.40/1 | A-5781.46/1S | A-5782.26/1 | A-5785.13/1S |
| A-5281.20/1 | A-5780.17/1 | A-5780.40/1S | A-5781.48/1 | A-5782.26/1S | A-5785.14/1 |
| A-5281.20/1S | A-5780.17/1S | A-5780.42/1 | A-5781.48/1S | A-5782.27/1 | A-5785.14/1S |
| A-5282.06/1 | A-5780.18/1 | A-5780.42/1S | A-5781.50/1 | A-5782.27/1S | A-5785.15/1 |
| A-5282.06/1S | A-5780.18/1S | A-5780.44/1 | A-5781.50/1S | A-5782.28/1 | A-5785.15/1S |
| A-5282.07/1 | A-5780.19/1 | A-5780.44/1S | A-5781.55/1 | A-5782.28/1S | A-5785.16/1 |
| A-5282.07/1S | A-5780.19/1S | A-5780.46/1 | A-5781.55/1S | A-5782.29/1 | A-5785.16/1S |
| A-5282.08/1 | A-5780.20/1 | A-5780.46/1S | A-5782.10/1 | A-5782.29/1S | A-5785.17/1 |
| A-5282.08/1S | A-5780.20/1S | A-5780.48/1 | A-5782.10/1S | A-5782.30/1 | A-5785.17/1S |
| A-5282.09/1 | A-5780.21/1 | A-5780.48/1S | A-5782.11/1 | A-5782.30/1S | A-5785.18/1 |
| A-5282.09/1S | A-5780.21/1S | A-5780.50/1 | A-5782.11/1S | A-5782.32/1 | A-5785.18/1S |
| A-5282.10/1 | A-5780.22/1 | A-5780.50/1S | A-5782.12/1 | A-5782.32/1S | A-5785.19/1 |
| A-5282.10/1S | A-5780.22/1S | A-5780.55/1 | A-5782.12/1S | A-5782.34/1 | A-5785.19/1S |
| A-5282.11/1 | A-5780.23/1 | A-5780.55/1S | A-5782.13/1 | A-5782.34/1S | A-5785.20/1 |
| A-5282.11/1S | A-5780.23/1S | A-5781.22/1 | A-5782.13/1S | A-5782.36/1 | A-5785.20/1S |
| A-5282.12/1 | A-5781.22/1 | A-5781.22/1S | A-5782.14/1 | A-5782.36/1S | A-5785.21/1 |
| A-5282.12/1S | A-5781.22/1S | A-5781.24/1 | A-5782.14/1S | A-5782.38/1 | A-5785.21/1S |
| A-5282.13/1 | A-5780.24/1 | A-5781.24/1S | A-5782.15/1 | A-5782.38/1S | A-5785.22/1 |
| A-5282.13/1S | A-5780.24/1S | A-5781.26/1 | A-5782.15/1S | A-5782.40/1 | A-5785.22/1S |
| | A-5780.25/1 | A-5781.26/1S | A-5782.16/1 | A-5782.40/1S | A-5785.23/1 |

| | | | | | |
|--------------|--------------|--------------|--------------|--------------|--------------|
| A-5785.23/1S | A-5786.32/1 | A-5880.28/1S | A-5881.40/1 | A-5882.23/1S | A-5885.12/1 |
| A-5785.24/1 | A-5786.32/1S | A-5880.29/1 | A-5881.40/1S | A-5882.24/1 | A-5885.12/1S |
| A-5785.24/1S | A-5786.34/1 | A-5880.29/1S | A-5881.42/1 | A-5882.24/1S | A-5885.13/1 |
| A-5785.25/1 | A-5786.34/1S | A-5880.30/1 | A-5881.42/1S | A-5882.25/1 | A-5885.13/1S |
| A-5785.25/1S | A-5786.36/1 | A-5880.30/1S | A-5881.44/1 | A-5882.25/1S | A-5885.14/1 |
| A-5785.26/1 | A-5786.36/1S | A-5880.32/1 | A-5881.44/1S | A-5882.26/1 | A-5885.14/1S |
| A-5785.26/1S | A-5786.38/1 | A-5880.32/1S | A-5881.46/1 | A-5882.26/1S | A-5885.15/1 |
| A-5785.27/1 | A-5786.38/1S | A-5880.34/1 | A-5881.46/1S | A-5882.27/1 | A-5885.15/1S |
| A-5785.27/1S | A-5786.40/1 | A-5880.34/1S | A-5881.48/1 | A-5882.27/1S | A-5885.16/1 |
| A-5785.28/1 | A-5786.40/1S | A-5880.36/1 | A-5881.48/1S | A-5882.28/1 | A-5885.16/1S |
| A-5785.28/1S | A-5880.10/1 | A-5880.36/1S | A-5881.50/1 | A-5882.28/1S | A-5885.17/1 |
| A-5785.29/1 | A-5880.10/1S | A-5880.38/1 | A-5881.50/1S | A-5882.29/1 | A-5885.17/1S |
| A-5785.29/1S | A-5880.11/1 | A-5880.38/1S | A-5881.55/1 | A-5882.29/1S | A-5885.18/1 |
| A-5785.30/1 | A-5880.11/1S | A-5880.40/1 | A-5881.55/1S | A-5882.30/1 | A-5885.18/1S |
| A-5785.30/1S | A-5880.12/1 | A-5880.40/1S | A-5881.60/1 | A-5882.30/1S | A-5885.19/1 |
| A-5785.32/1 | A-5880.12/1S | A-5880.42/1 | A-5881.60/1S | A-5882.32/1 | A-5885.19/1S |
| A-5785.32/1S | A-5880.13/1 | A-5880.42/1S | A-5881.65/1 | A-5882.32/1S | A-5885.20/1 |
| A-5785.34/1 | A-5880.13/1S | A-5880.44/1 | A-5881.65/1S | A-5882.34/1 | A-5885.20/1S |
| A-5785.34/1S | A-5880.14/1 | A-5880.44/1S | A-5881.70/1 | A-5882.34/1S | A-5885.22/1 |
| A-5785.36/1 | A-5880.14/1S | A-5880.46/1 | A-5881.70/1S | A-5882.36/1 | A-5885.22/1S |
| A-5785.36/1S | A-5880.15/1 | A-5880.46/1S | A-5882.10/1 | A-5882.36/1S | A-5885.23/1 |
| A-5785.38/1 | A-5880.15/1S | A-5880.48/1 | A-5882.10/1S | A-5882.38/1 | A-5885.23/1S |
| A-5785.38/1S | A-5880.16/1 | A-5880.48/1S | A-5882.11/1 | A-5882.38/1S | A-5885.24/1 |
| A-5785.40/1 | A-5880.16/1S | A-5880.50/1 | A-5882.11/1S | A-5882.40/1 | A-5885.24/1S |
| A-5785.40/1S | A-5880.17/1 | A-5880.50/1S | A-5882.12/1 | A-5882.40/1S | A-5885.25/1 |
| A-5786.20/1 | A-5880.17/1S | A-5880.55/1 | A-5882.12/1S | A-5882.42/1 | A-5885.25/1S |
| A-5786.20/1S | A-5880.18/1 | A-5880.55/1S | A-5882.13/1 | A-5882.42/1S | A-5885.26/1 |
| A-5786.21/1 | A-5880.18/1S | A-5880.60/1 | A-5882.13/1S | A-5882.44/1 | A-5885.26/1S |
| A-5786.21/1S | A-5880.19/1 | A-5880.60/1S | A-5882.14/1 | A-5882.44/1S | A-5885.27/1 |
| A-5786.22/1 | A-5880.19/1S | A-5880.65/1 | A-5882.14/1S | A-5882.46/1 | A-5885.27/1S |
| A-5786.22/1S | A-5880.20/1 | A-5880.65/1S | A-5882.15/1 | A-5882.46/1S | A-5885.28/1 |
| A-5786.23/1 | A-5880.20/1S | A-5880.70/1 | A-5882.15/1S | A-5882.48/1 | A-5885.28/1S |
| A-5786.23/1S | A-5880.21/1 | A-5880.70/1S | A-5882.16/1 | A-5882.48/1S | A-5885.29/1 |
| A-5786.24/1 | A-5880.21/1S | A-5881.26/1 | A-5882.16/1S | A-5882.50/1 | A-5885.29/1S |
| A-5786.24/1S | A-5880.22/1 | A-5881.26/1S | A-5882.17/1 | A-5882.50/1S | A-5885.30/1 |
| A-5786.25/1 | A-5880.22/1S | A-5881.28/1 | A-5882.17/1S | A-5882.55/1 | A-5885.30/1S |
| A-5786.25/1S | A-5880.23/1 | A-5881.28/1S | A-5882.18/1 | A-5882.55/1S | A-5885.32/1 |
| A-5786.26/1 | A-5880.23/1S | A-5881.30/1 | A-5882.18/1S | A-5882.60/1 | A-5885.32/1S |
| A-5786.26/1S | A-5880.24/1 | A-5881.30/1S | A-5882.19/1 | A-5882.60/1S | A-5885.34/1 |
| A-5786.27/1 | A-5880.24/1S | A-5881.32/1 | A-5882.19/1S | A-5882.65/1 | A-5885.34/1S |
| A-5786.27/1S | A-5880.25/1 | A-5881.32/1S | A-5882.20/1 | A-5882.65/1S | A-5885.36/1 |
| A-5786.28/1 | A-5880.25/1S | A-5881.34/1 | A-5882.20/1S | A-5882.70/1 | A-5885.36/1S |
| A-5786.28/1S | A-5880.26/1 | A-5881.34/1S | A-5882.21/1 | A-5882.70/1S | A-5885.38/1 |
| A-5786.29/1 | A-5880.26/1S | A-5881.36/1 | A-5882.21/1S | A-5885.10/1 | A-5885.38/1S |
| A-5786.29/1S | A-5880.27/1 | A-5881.36/1S | A-5882.22/1 | A-5885.10/1S | A-5885.40/1 |
| A-5786.30/1 | A-5880.27/1S | A-5881.38/1 | A-5882.22/1S | A-5885.11/1 | A-5885.40/1S |
| A-5786.30/1S | A-5880.28/1 | A-5881.38/1S | A-5882.23/1 | A-5885.11/1S | A-5886.20/1 |

| | | | | | |
|--------------|--------------|--------------|--------------|---------------|---------------|
| A-5886.20/1S | A-8110.30/1 | A-8111.32/1S | A-8112.32/1 | A-8115.30/1S | A-8116.42/1 |
| A-5886.21/1 | A-8110.30/1S | A-8111.34/1 | A-8112.32/1S | A-8115.32/1 | A-8116.42/1S |
| A-5886.21/1S | A-8110.32/1 | A-8111.34/1S | A-8112.34/1 | A-8115.32/1S | A-8116.44/1 |
| A-5886.21/1 | A-8110.32/1S | A-8111.36/1 | A-8112.34/1S | A-8115.34/1 | A-8116.44/1S |
| A-5886.21/1S | A-8110.34/1 | A-8111.36/1S | A-8112.36/1 | A-8115.34/1S | A-8116.46/1 |
| A-5886.22/1 | A-8110.34/1S | A-8111.38/1 | A-8112.36/1S | A-8115.36/1 | A-8116.46/1S |
| A-5886.22/1S | A-8110.36/1 | A-8111.38/1S | A-8112.38/1 | A-8115.36/1S | A-8116.48/1 |
| A-5886.23/1 | A-8110.36/1S | A-8111.40/1 | A-8112.38/1S | A-8115.38/1 | A-8116.48/1S |
| A-5886.23/1S | A-8110.38/1 | A-8111.40/1S | A-8112.40/1 | A-8115.38/1S | A-8116.50/1 |
| A-5886.24/1 | A-8110.38/1S | A-8111.42/1 | A-8112.40/1S | A-8115.40/1 | A-8116.50/1S |
| A-5886.24/1S | A-8110.40/1 | A-8111.42/1S | A-8112.42/1 | A-8115.40/1S | A-8116.55/1 |
| A-5886.25/1 | A-8110.40/1S | A-8111.44/1 | A-8112.42/1S | A-8115.42/1 | A-8116.556/1S |
| A-5886.25/1S | A-8110.42/1 | A-8111.44/1S | A-8112.44/1 | A-8115.42/1S | A-8116.60/1 |
| A-5886.26/1 | A-8110.42/1S | A-8111.46/1 | A-8112.44/1S | A-8115.44/1 | A-8116.60/1S |
| A-5886.26/1S | A-8110.44/1 | A-8111.46/1S | A-8112.46/1 | A-8115.44/1S | A-8117.16/1 |
| A-5886.27/1 | A-8110.44/1S | A-8111.48/1 | A-8112.46/1S | A-8115.46/1 | A-8117.16/1S |
| A-5886.27/1S | A-8110.46/1 | A-8111.48/1S | A-8112.48/1 | A-8115.46/1S | A-8117.18/1 |
| A-5886.28/1 | A-8110.46/1S | A-8111.50/1 | A-8112.48/1S | A-8115.48/1 | A-8117.18/1S |
| A-5886.28/1S | A-8110.48/1 | A-8111.50/1S | A-8112.50/1 | A-8115.48/1S | A-8117.20/1 |
| A-5886.29/1 | A-8110.48/1S | A-8111.55/1 | A-8112.50/1S | A-8115.50/1 | A-8117.20/1S |
| A-5886.29/1S | A-8110.50/1 | A-8111.55/1S | A-8112.55/1 | A-8115.50/1S | A-8117.22/1 |
| A-5886.30/1 | A-8110.50/1S | A-8111.60/1 | A-8112.55/1S | A-8115.55/1 | A-8117.22/1S |
| A-5886.30/1S | A-8110.55/1 | A-8111.60/1S | A-8112.60/1 | A-8115.556/1S | A-8117.24/1 |
| A-5886.32/1 | A-8110.55/1S | A-8111.65/1 | A-8112.60/1S | A-8115.60/1 | A-8117.24/1S |
| A-5886.32/1S | A-8110.60/1 | A-8111.65/1S | A-8112.65/1 | A-8115.60/1S | A-8117.26/1 |
| A-5886.34/1 | A-8110.60/1S | A-8111.70/1 | A-8112.65/1S | A-8116.20/1 | A-8117.26/1S |
| A-5886.34/1S | A-8110.65/1 | A-8111.70/1S | A-8112.70/1 | A-8116.20/1S | A-8117.28/1 |
| A-5886.36/1 | A-8110.65/1S | A-8111.75/1 | A-8112.70/1S | A-8116.22/1 | A-8117.28/1S |
| A-5886.36/1S | A-8110.70/1 | A-8111.75/1S | A-8112.75/1 | A-8116.22/1S | A-8117.30/1 |
| A-5886.38/1 | A-8110.70/1S | A-8111.80/1 | A-8112.75/1S | A-8116.24/1 | A-8117.30/1S |
| A-5886.38/1S | A-8110.75/1 | A-8111.80/1S | A-8112.80/1 | A-8116.24/1S | A-8117.32/1 |
| A-5886.40/1 | A-8110.75/1S | A-8112.16/1 | A-8112.80/1S | A-8116.26/1 | A-8117.32/1S |
| A-5886.40/1S | A-8110.80/1 | A-8112.16/1S | A-8115.16/1 | A-8116.26/1S | A-8117.34/1 |
| A-8110.16/1 | A-8110.80/1S | A-8112.18/1 | A-8115.16/1S | A-8116.28/1 | A-8117.34/1S |
| A-8110.16/1S | A-8111.20/1 | A-8112.18/1S | A-8115.18/1 | A-8116.28/1S | A-8117.36/1 |
| A-8110.18/1 | A-8111.20/1S | A-8112.20/1 | A-8115.18/1S | A-8116.30/1 | A-8117.36/1S |
| A-8110.18/1S | A-8111.22/1 | A-8112.20/1S | A-8115.20/1 | A-8116.30/1S | A-8117.38/1 |
| A-8110.20/1 | A-8111.22/1S | A-8112.22/1 | A-8115.20/1S | A-8116.32/1 | A-8117.38/1S |
| A-8110.20/1S | A-8111.24/1 | A-8112.22/1S | A-8115.22/1 | A-8116.32/1S | A-8117.40/1 |
| A-8110.22/1 | A-8111.24/1S | A-8112.24/1 | A-8115.22/1S | A-8116.34/1 | A-8117.40/1S |
| A-8110.22/1S | A-8111.26/1 | A-8112.24/1S | A-8115.24/1 | A-8116.34/1S | A-8117.42/1 |
| A-8110.24/1 | A-8111.26/1S | A-8112.26/1 | A-8115.24/1S | A-8116.36/1 | A-8117.42/1S |
| A-8110.24/1S | A-8111.28/1 | A-8112.26/1S | A-8115.26/1 | A-8116.36/1S | A-8117.44/1 |
| A-8110.26/1 | A-8111.28/1S | A-8112.28/1 | A-8115.26/1S | A-8116.38/1 | A-8117.44/1S |
| A-8110.26/1S | A-8111.30/1 | A-8112.28/1S | A-8115.28/1 | A-8116.38/1S | A-8117.46/1 |
| A-8110.28/1 | A-8111.30/1S | A-8112.30/1 | A-8115.28/1S | A-8116.40/1 | A-8117.46/1S |
| A-8110.28/1S | A-8111.32/1 | A-8112.30/1S | A-8115.30/1 | A-8116.40/1S | A-8117.48/1 |

| | | | | |
|---------------|--------------|--------------|--------------|---------------|
| A-8117.48/1S | A-8211.40/1 | A-8215.26/1S | A-8216.65/1 | A-8410.60/1S |
| A-8117.50/1 | A-8211.40/1S | A-8215.28/1 | A-8216.65/1S | A-8410.65/1 |
| A-8117.50/1S | A-8211.45/1 | A-8215.28/1S | A-8216.70/1 | A-8410.65/1S |
| A-8117.55/1 | A-8211.45/1S | A-8215.30/1 | A-8216.70/1S | A-8410.70/1 |
| A-8117.556/1S | A-8211.50/1 | A-8215.30/1S | A-8217.24/1 | A-8410.70/1S |
| A-8117.60/1 | A-8211.50/1S | A-8215.32/1 | A-8217.24/1S | A-8410.75/1 |
| A-8117.60/1S | A-8211.55/1 | A-8215.32/1S | A-8217.26/1 | A-8410.75/1S |
| A-8210.24/1 | A-8211.55/1S | A-8215.34/1 | A-8217.26/1S | A-8410.80/1 |
| A-8210.24/1S | A-8211.60/1 | A-8215.34/1S | A-8217.28/1 | A-8410.80/1S |
| A-8210.26/1 | A-8211.60/1S | A-8215.36/1 | A-8217.28/1S | A-8410.85/1 |
| A-8210.26/1S | A-8211.65/1 | A-8215.36/1S | A-8217.30/1 | A-8410.85/1S |
| A-8210.28/1 | A-8211.65/1S | A-8215.38/1 | A-8217.30/1S | A-8410.90/1 |
| A-8210.28/1S | A-8211.70/1 | A-8215.38/1S | A-8217.32/1 | A-8410.90/1S |
| A-8210.30/1 | A-8211.70/1S | A-8215.40/1 | A-8217.32/1S | A-8410.95/1 |
| A-8210.30/1S | A-8212.24/1 | A-8215.40/1S | A-8217.34/1 | A-8410.95/1S |
| A-8210.32/1 | A-8212.24/1S | A-8215.45/1 | A-8217.34/1S | A-8410.100/1 |
| A-8210.32/1S | A-8212.26/1 | A-8215.45/1S | A-8217.36/1 | A-8410.100/1S |
| A-8210.34/1 | A-8212.26/1S | A-8215.50/1 | A-8217.36/1S | A-8410.105/1 |
| A-8210.34/1S | A-8212.28/1 | A-8215.50/1S | A-8217.38/1 | A-8410.105/1S |
| A-8210.36/1 | A-8212.28/1S | A-8215.55/1 | A-8217.38/1S | A-8410.110/1 |
| A-8210.36/1S | A-8212.30/1 | A-8215.55/1S | A-8217.40/1 | A-8410.11/1S |
| A-8210.38/1 | A-8212.30/1S | A-8215.60/1 | A-8217.40/1S | A-8410.120/1 |
| A-8210.38/1S | A-8212.32/1 | A-8215.60/1S | A-8217.45/1 | A-8410.120/1S |
| A-8210.40/1 | A-8212.32/1S | A-8215.65/1 | A-8217.45/1S | A-8410.130/1 |
| A-8210.40/1S | A-8212.34/1 | A-8215.65/1S | A-8217.50/1 | A-8410.130/1S |
| A-8210.45/1 | A-8212.34/1S | A-8215.70/1 | A-8217.50/1S | A-8410.140/1 |
| A-8210.45/1S | A-8212.36/1 | A-8215.70/1S | A-8217.55/1 | A-8410.140/1S |
| A-8210.50/1 | A-8212.36/1S | A-8216.30/1 | A-8217.55/1S | A-8411.35/1S |
| A-8210.50/1S | A-8212.38/1 | A-8216.30/1S | A-8217.60/1 | A-8411.40/1 |
| A-8210.55/1 | A-8212.38/1S | A-8216.32/1 | A-8217.60/1S | A-8411.40/1S |
| A-8210.55/1S | A-8212.40/1 | A-8216.32/1S | A-8217.65/1 | A-8411.45/1 |
| A-8210.60/1 | A-8212.40/1S | A-8216.34/1 | A-8217.65/1S | A-8411.45/1S |
| A-8210.60/1S | A-8212.45/1 | A-8216.34/1S | A-8217.70/1 | A-8411.50/1 |
| A-8210.65/1 | A-8212.45/1S | A-8216.36/1 | A-8217.70/1S | A-8411.50/1S |
| A-8210.65/1S | A-8212.50/1 | A-8216.36/1S | A-8410.30/1 | A-8411.55/1 |
| A-8210.70/1 | A-8212.50/1S | A-8216.38/1 | A-8410.30/1S | A-8411.55/1S |
| A-8210.70/1S | A-8212.55/1 | A-8216.38/1S | A-8410.35/1 | A-8411.60/1 |
| A-8211.30/1 | A-8212.55/1S | A-8216.40/1 | A-8410.35/1S | A-8411.60/1S |
| A-8211.30/1S | A-8212.60/1 | A-8216.40/1S | A-8410.40/1 | A-8411.65/1 |
| A-8211.32/1 | A-8212.60/1S | A-8216.45/1 | A-8410.40/1S | A-8411.65/1S |
| A-8211.32/1S | A-8212.65/1 | A-8216.45/1S | A-8410.45/1 | A-8411.70/1 |
| A-8211.34/1 | A-8212.65/1S | A-8216.50/1 | A-8410.45/1S | A-8411.70/1S |
| A-8211.34/1S | A-8212.70/1 | A-8216.50/1S | A-8410.50/1 | A-8411.75/1 |
| A-8211.36/1 | A-8212.70/1S | A-8216.55/1 | A-8410.50/1S | A-8411.75/1S |
| A-8211.36/1S | A-8215.24/1 | A-8216.55/1S | A-8410.55/1 | A-8411.80/1 |
| A-8211.38/1 | A-8215.24/1S | A-8216.60/1 | A-8410.55/1S | A-8411.80/1S |
| A-8211.38/1S | A-8215.26/1 | A-8216.60/1S | A-8410.60/1 | A-8411.85/1 |

| | | | | |
|---------------|---------------|---------------|----------------|---------------------|
| A-8411.85/1S | A-8412.105/1 | A-8415.130/1S | A-8417.45/1 | Twist Drills |
| A-8411.90/1 | A-8412.105/1S | A-8415.140/1 | A-8417.45/1S | A-3236 |
| A-8411.90/1S | A-8412.110/1 | A-8415.140/1S | A-8417.50/1 | A-3236S |
| A-8411.95/1 | A-8412.110/1S | A-8416.35/1 | A-8417.50/1S | A-3736 |
| A-8411.95/1S | A-8412.120/1 | A-8416.35/1S | A-8417.55/1 | A-3736S |
| A-8411.100/1 | A-8412.120/1S | A-8416.40/1 | A-8417.55/1S | A-3738 |
| A-8411.100/1S | A-8412.130/1 | A-8416.40/1S | A-8417.60/1 | A-3738S |
| A-8411.105/1 | A-8412.130/1S | A-8416.45/1 | A-8417.60/1S | A-3741 |
| A-8411.105/1S | A-8412.140/1 | A-8416.45/1S | A-8417.65/1 | A-3741S |
| A-8411.110/1 | A-8412.140/1S | A-8416.50/1 | A-8417.65/1S | A-3836 |
| A-8411.11/1S | A-8415.30/1 | A-8416.50/1S | A-8417.70/1 | A-3836S |
| A-8411.120/1 | A-8415.30/1S | A-8416.55/1 | A-8417.70/1S | A-3838 |
| A-8411.120/1S | A-8415.35/1 | A-8416.55/1S | A-8417.75/1 | A-3838S |
| A-8411.130/1 | A-8415.35/1S | A-8416.60/1 | A-8417.75/1S | A-3840 |
| A-8411.130/1S | A-8415.40/1 | A-8416.60/1S | A-8417.80/1 | A-3840S |
| A-8411.140/1 | A-8415.40/1S | A-8416.65/1 | A-8417.80/1S | A-3841 |
| A-8411.140/1S | A-8415.45/1 | A-8416.65/1S | A-8417.85/1 | A-3841S |
| A-8412.30/1 | A-8415.45/1S | A-8416.70/1 | A-8417.85/1S | A-8000.03 |
| A-8412.30/1S | A-8415.50/1 | A-8416.70/1S | A-8417.90/1 | A-8000.03S |
| A-8412.35/1 | A-8415.50/1S | A-8416.75/1 | A-8417.90/1S | A-8001.01 |
| A-8412.35/1S | A-8415.55/1 | A-8416.75/1S | A-8417.95/1 | A-8001.01S |
| A-8412.40/1 | A-8415.55/1S | A-8416.80/1 | A-8417.95/1S | A-8004.01 |
| A-8412.40/1S | A-8415.60/1 | A-8416.80/1S | A-8417.100/1 | A-8004.01S |
| A-8412.45/1 | A-8415.60/1S | A-8416.85/1 | A-8417.100/1S | A-8004.04 |
| A-8412.45/1S | A-8415.65/1 | A-8416.85/1S | A-8417.105/1 | A-8004.04S |
| A-8412.50/1 | A-8415.65/1S | A-8416.90/1 | A-8417.105/1S | |
| A-8412.50/1S | A-8415.70/1 | A-8416.90/1S | A-8417.110/1 | Countersinks |
| A-8412.55/1 | A-8415.70/1S | A-8416.95/1 | A-8417.110/1S | A-3932 |
| A-8412.55/1S | A-8415.75/1 | A-8416.95/1S | A-8417.120/1 | A-3932S |
| A-8412.60/1 | A-8415.75/1S | A-8416.100/1 | A-8417.120/1S | A-3935 |
| A-8412.60/1S | A-8415.80/1 | A-8416.100/1S | A-8417.130/1 | A-3935S |
| A-8412.65/1 | A-8415.80/1S | A-8416.105/1 | A-8417.130/1S | A-3936 |
| A-8412.65/1S | A-8415.85/1 | A-8416.105/1S | A-8417.140/1 | A-3936S |
| A-8412.70/1 | A-8415.85/1S | A-8416.110/1 | A-8417.140/1S | A-3937 |
| A-8412.70/1S | A-8415.90/1 | A-8416.110/1S | | A-3937S |
| A-8412.75/1 | A-8415.90/1S | A-8416.120/1 | Washers | A-3938 |
| A-8412.75/1S | A-8415.95/1 | A-8416.120/1S | A-4700.71/1 | A-3938S |
| A-8412.80/1 | A-8415.95/1S | A-8416.130/1 | A-4700.71/1S | A-8000.04 |
| A-8412.80/1S | A-8415.100/1 | A-8416.130/1S | A-4800.70/1 | A-8000.04S |
| A-8412.85/1 | A-8415.100/1S | A-8416.140/1 | A-4800.70/1S | A-8000.05 |
| A-8412.85/1S | A-8415.105/1 | A-8416.140/1S | A-8140.70/1 | A-8000.05S |
| A-8412.90/1 | A-8415.105/1S | A-8417.30/1 | A-8140.70/1S | A-8001.02 |
| A-8412.90/1S | A-8415.110/1 | A-8417.30/1S | A-8240.70/1 | A-8001.02S |
| A-8412.95/1 | A-8415.110/1S | A-8417.35/1 | A-8240.70/1S | A-8001.03 |
| A-8412.95/1S | A-8415.120/1 | A-8417.35/1S | A-8440.70/1 | A-8001.03S |
| A-8412.100/1 | A-8415.120/1S | A-8417.40/1 | A-8440.70/1S | A-8004.02 |
| A-8412.100/1S | A-8415.130/1 | A-8417.40/1S | | A-8004.02S |

| | | | |
|----------------|--------------------|-------------------|------------|
| A-8004.03 | A-5044.42/1 | A-8004.24 | A-6603.095 |
| A-8004.03S | A-5044.42/1S | A-8004.25 | A-6603.111 |
| | A-5044.74 | A-8004.27 | A-6603.121 |
| K-Wires | A-5044.74/1 | A-8004.28 | A-6603.131 |
| A-5040.00 | A-5044.74/1S | | A-6603.141 |
| A-5040.00/1 | | Containers | A-6603.411 |
| A-5040.00/1S | Instruments | A-6010.08 | A-6603.421 |
| A-5040.01 | A-2007 | A-6010.11 | A-6603.431 |
| A-5040.01/1 | A-2008 | A-6603.001 | A-6603.441 |
| A-5040.01/1S | A-2009 | A-6603.003 | A-6603.442 |
| A-5040.10 | A-2027 | A-6603.004 | A-6603.443 |
| A-5040.10/1 | A-2035 | A-6603.011 | A-6603.444 |
| A-5040.10/1S | A-2038 | A-6603.013 | A-6603.445 |
| A-5040.11 | A-2039 | A-6603.014 | A-6603.461 |
| A-5040.11/1 | A-2065 | A-6603.020 | A-6603.471 |
| A-5040.11/1S | A-2073 | A-6603.021 | A-6603.481 |
| A-5040.30 | A-2077 | A-6603.022 | A-6603.511 |
| A-5040.30/1 | A-2206 | A-6603.023 | A-6603.521 |
| A-5040.30/1S | A-2216 | A-6603.025 | A-6603.531 |
| A-5040.42 | A-2225 | A-6603.026 | A-6603.541 |
| A-5040.42/1 | A-2235 | A-6603.031 | A-6603.542 |
| A-5040.42/1S | A-2706 | A-6603.032 | A-6603.543 |
| A-5040.74 | A-2716 | A-6603.033 | A-6603.561 |
| A-5040.74/1 | A-2806 | A-6603.034 | A-6603.571 |
| A-5040.74/1S | A-2816 | A-6603.035 | A-6603.581 |
| A-5040.90 | A-2835 | A-6603.036 | A-6603.721 |
| A-5040.90/1 | A-2725 | A-6603.041 | A-6603.731 |
| A-5040.90/1S | A-2824 | A-6603.042 | A-6603.741 |
| A-5042.00 | A-2825 | A-6603.043 | A-6603.742 |
| A-5042.00/1 | A-7011 | A-6603.044 | A-6603.743 |
| A-5042.00/1S | A-8000.12 | A-6603.045 | A-6603.761 |
| A-5042.10 | A-8000.20 | A-6603.046 | A-6603.781 |
| A-5042.10/1 | A-8000.21 | A-6603.051 | A-6610.50 |
| A-5042.10/1S | A-8000.23 | A-6603.052 | A-6611 |
| A-5043.00 | A-8000.24 | A-6603.053 | M-6706 |
| A-5043.00/1 | A-8000.25 | A-6603.054 | M-6707 |
| A-5043.00/1S | A-8000.27 | A-6603.055 | M-6710 |
| A-5043.10 | A-8001.10 | A-6603.056 | M-6720 |
| A-5043.10/1 | A-8001.11 | A-6603.057 | M-6726 |
| A-5043.10/1S | A-8001.12 | A-6603.058 | M-6727 |
| A-5043.90 | A-8001.23 | A-6603.061 | |
| A-5043.90/1 | A-8001.24 | A-6603.071 | |
| A-5043.90/1S | A-8001.25 | A-6603.081 | |
| A-5044.30 | A-8001.27 | A-6603.091 | |
| A-5044.30/1 | A-8004.11 | A-6603.092 | |
| A-5044.30/1S | A-8004.12 | A-6603.093 | |
| A-5044.42 | A-8004.23 | A-6603.094 | |

R_CCS-01010001_v5 / © 2024-02, Medartis AG, Switzerland. All technical data subject to alteration.

MANUFACTURER & HEADQUARTERS

Medartis AG | Hochbergerstrasse 60E | 4057 Basel / Switzerland

P +41 61 633 34 34 | F +41 61 633 34 00 | www.medartis.com

SUBSIDIARIES

Australia | Austria | Brazil | France | Germany | Japan | Mexico | New Zealand | Poland | Spain | UK | USA

For detailed information regarding our subsidiaries and distributors, please visit www.medartis.com



Disclaimer: This information is intended to demonstrate the Medartis portfolio of medical devices. A surgeon must always rely on her or his own professional clinical judgement when deciding whether to use a particular product when treating a particular patient. Medartis is not giving any medical advice. The devices may not be available in all countries due to registration and/or medical practices. For further questions, please contact your Medartis representative (www.medartis.com). This information contains products with CE and/or UKCA-marking. All pictures shown are for illustration purposes only and may not be an exact representation of the product. For US only: Federal law restricts this device to sale by or on the order of a physician.

© Medartis 2024. Everything herein is protected by copyright, trademarks and other intellectual property rights, as applicable, owned by or licensed to Medartis or its affiliates unless otherwise indicated. It is forbidden to redistribute, duplicate or disclose anything herein, in whole or in part, without the prior written consent of Medartis.