

medartis®

PRECISION IN FIXATION

PRODUCT INFORMATION

Ulna Shortening System 2.5

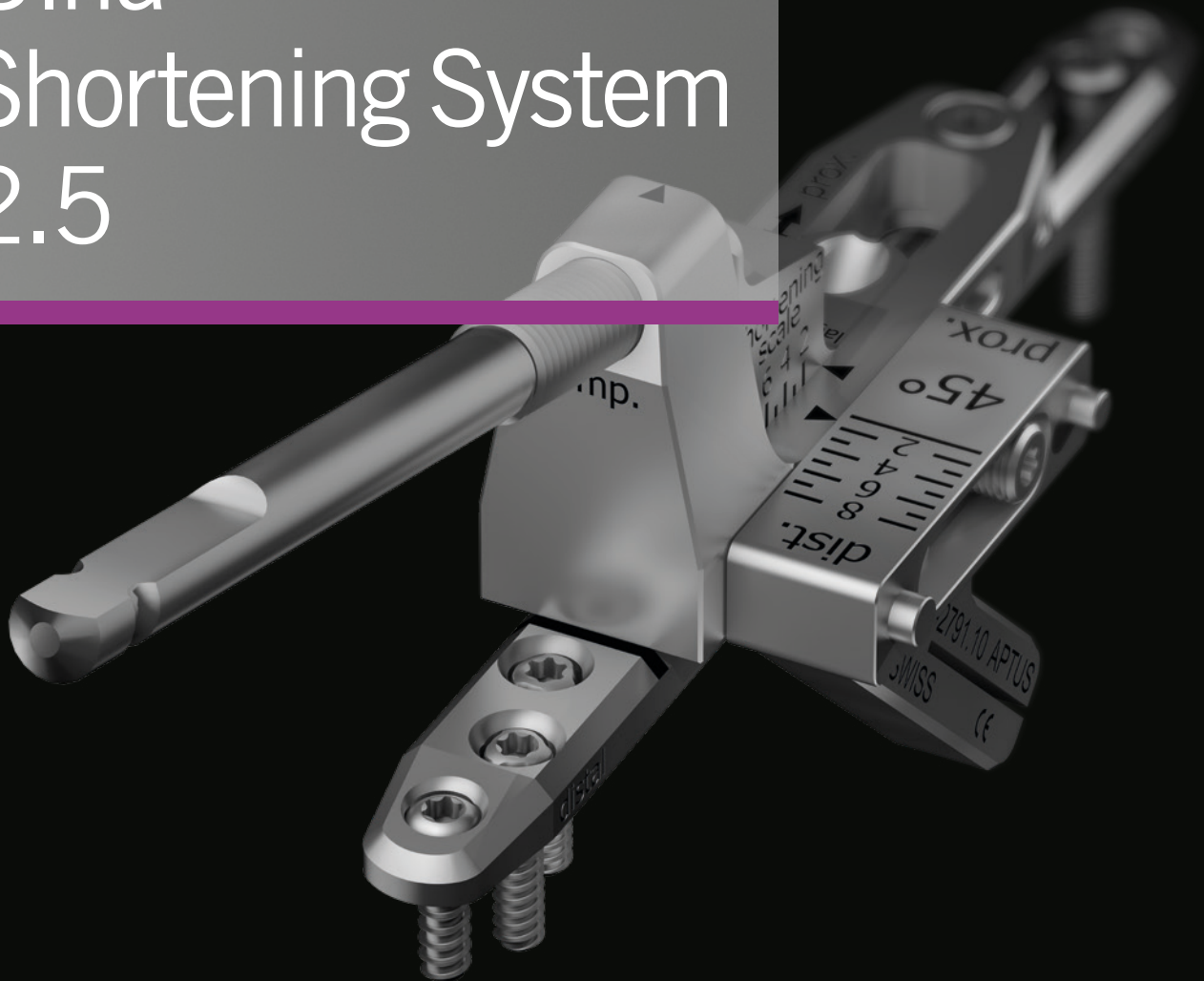

APTUS®
Wrist

Ulna Shortening System 2.5

Osteotomies with angular stable plating and guided, rotation-proof compression

System Features

- Osteotomies can be performed with either a 45° or 90° angle
- Chamfered edges and a smooth surface for soft tissue protection
- TriLock – multidirectional ($\pm 15^\circ$) and angular stable locking technology
- Compatible with the screws and instruments of the APTUS Distal Radius System 2.5



Clinical Benefits

- Rotation-proof and guided compression
- Finely adjustable saw guide (2-8 mm) for precise and parallel osteotomies
- Controlled compression is generated and maintained by means of the spindle
- Recess on the plate allows for osteotomy with fixed plate
- Low plate profile of 3.2 mm

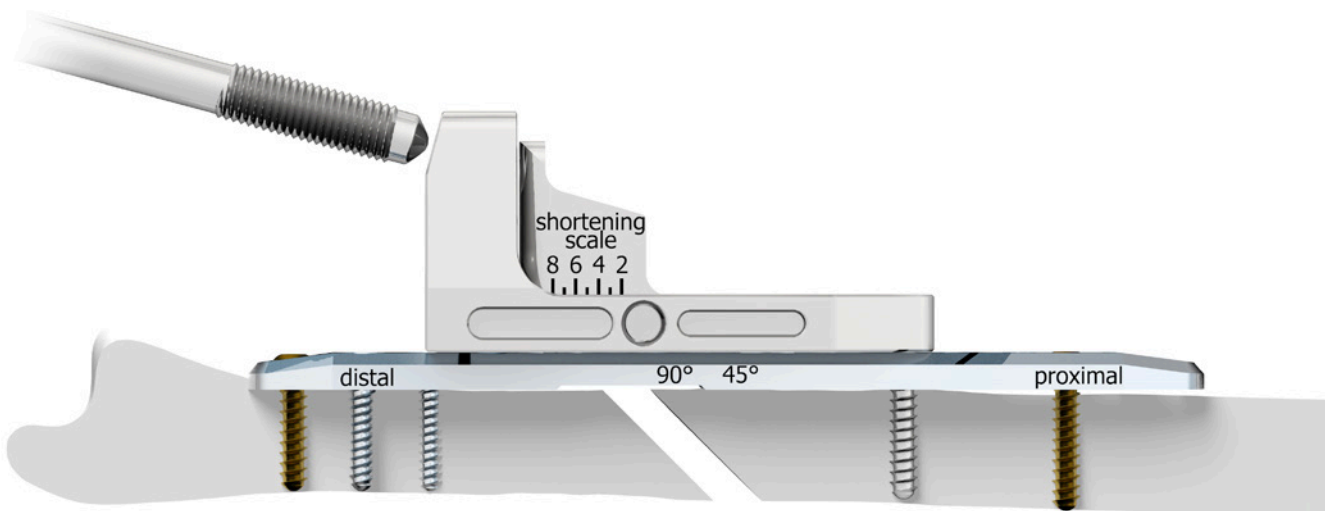
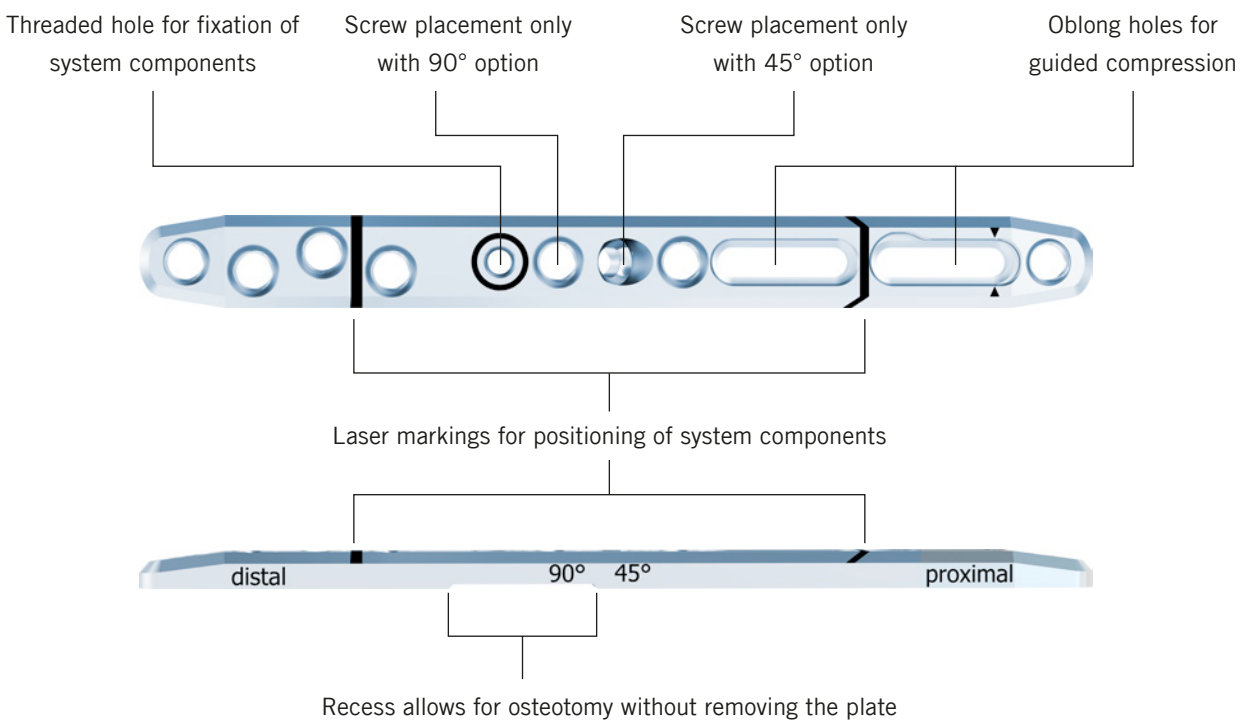

Clinical Case with 45° Osteotomy



Ulna impaction syndrome



The saw guide allows for 45° osteotomy with the plate in position

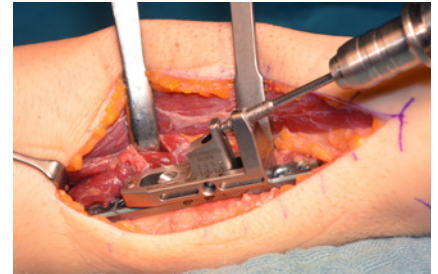

Guided, rotation-proof compression of the osteotomy gap by means of the spindle

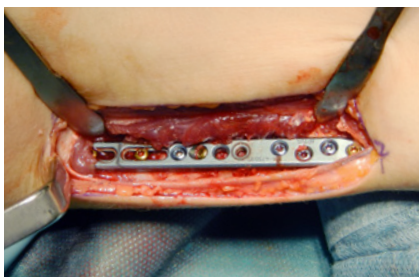

Fixed plate after compression



X-ray control, seven months postoperative with completed restoration of the bone

Clinical Case with 90° Osteotomy



Ulna impaction syndrome

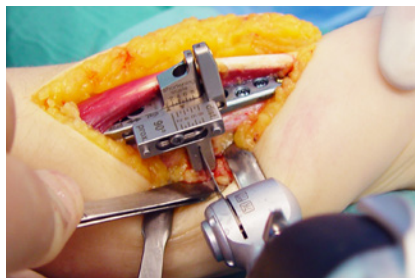

The saw guide allows for 90° osteotomy with the plate in position

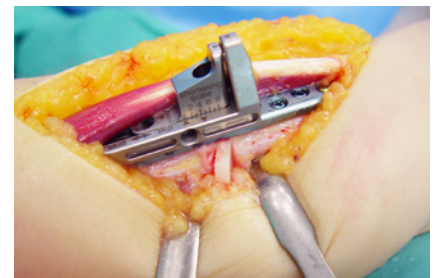

Removal of the bone wafer

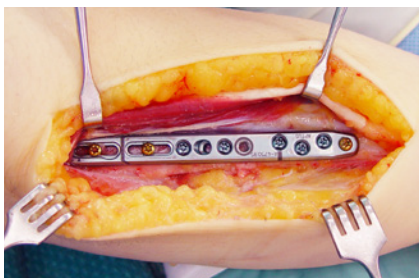

Fixed plate after compression

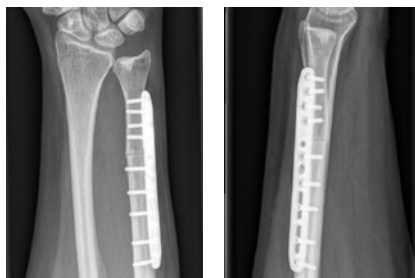

Postoperative X-ray

Clinical cases published with the kind permission of:

45° osteotomy: M. Sauerbier, Frankfurt, Germany | 90° osteotomy: J. Grünert, St. Gallen, Switzerland

Ordering Information

2.5 TriLock Ulna Shortening Plate

Material: Titanium (ASTM F67)
Plate thickness: 3.2 mm

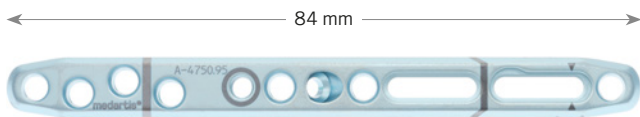

Art. No.	Holes	Pieces/Pkg
A-4750.95	10	1

Basic Element



Art. No.	Pieces/Pkg
A-2791.03	1

Saw Guides (incl. Screw)



A-2791.10

A-2791.20

Art. No.	Description	Pieces/Pkg
A-2791.10	45° (incl. screw)	1
A-2791.20	90° (incl. screw)	1
A-2791.01	screw for saw guide	1

Compression Element (incl. Screw)



Art. No.	Description	Pieces/Pkg
A-2791.30	incl. screw	1
A-2791.02	screw for compression element	1

Compression Spindle with Quick Connector



Art. No.	Shaft End	Pieces/Pkg
A-2791.04	AO	1

Temporary Tension Bolt



Art. No.	Description	Pieces/Pkg
A-2791.05	for single use	1

Saw Blades * STERILE



KM3.125 STE



KM3101 STE



KM519.013 STE

Art. No.	Connections for	Cutting Depth	Cutting Width	Material Thickness	Pieces/Pkg
KM3.125 STE	Stryker, NSK	31.00 mm	9.80 mm	0.40 mm	5
KM3101 STE	ConMed, Linvatec Hall, MicroAire, S&N Dyonics	25.50 mm	10.00 mm	0.40 mm	5
KM519.013 STE	Synthes, Zimmer UPS	25.00 mm	9.50 mm	0.40 mm	5

* Saw blades are available for the following countries: Austria, Belgium, Switzerland, Czech Republic, Germany, Denmark, Spain, France, UK, Greece, Croatia, Hungary, Ireland, Italy, Lithuania, Luxembourg, Latvia, Netherlands, Norway, Poland, Portugal, Sweden, Slovenia, Slovakia, USA

6 | Ulna Shortening System 2.5

2.5 Cortical Screws, HexaDrive 7

Material: Titanium (ASTM F136)



Length	Art. No.	Pieces/Pkg	Art. No.	Pieces/Pkg
8 mm	A-5700.08/1	1	A-5700.08	5
10 mm	A-5700.10/1	1	A-5700.10	5
12 mm	A-5700.12/1	1	A-5700.12	5
14 mm	A-5700.14/1	1	A-5700.14	5
16 mm	A-5700.16/1	1	A-5700.16	5
18 mm	A-5700.18/1	1	A-5700.18	5
20 mm	A-5700.20/1	1	A-5700.20	5
22 mm	A-5700.22/1	1	A-5700.22	5
24 mm	A-5700.24/1	1	A-5700.24	5
26 mm	A-5700.26/1	1	A-5700.26	5

2.5 TriLock Screws, HexaDrive 7

Material: Titanium (ASTM F136)

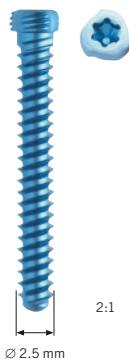

Length	Art. No.	Pieces/Pkg	Art. No.	Pieces/Pkg
8 mm	A-5750.08/1	1	A-5750.08	5
10 mm	A-5750.10/1	1	A-5750.10	5
12 mm	A-5750.12/1	1	A-5750.12	5
14 mm	A-5750.14/1	1	A-5750.14	5
16 mm	A-5750.16/1	1	A-5750.16	5
18 mm	A-5750.18/1	1	A-5750.18	5
20 mm	A-5750.20/1	1	A-5750.20	5
22 mm	A-5750.22/1	1	A-5750.22	5
24 mm	A-5750.24/1	1	A-5750.24	5

Twist Drills \varnothing 2.0 mm



A-3713



A-3723



A-3733

Art. No.	System Size	Stop	Length	Drill Shaft End	Pieces/Pkg
A-3713	2.5	40 mm	97 mm	Dental	1
A-3723	2.5	40 mm	97 mm	Stryker J-Latch	1
A-3733	2.5	40 mm	91 mm	AO Quick Coupling	1

Twist Drill Ø 2.6 mm (for Gliding Hole)



1:1

Art. No.	System Size	Stop	Length	Drill Shaft End	Pieces/Pkg
A-3731	2.5	10 mm	61 mm	AO Quick Coupling	1

Drill Guides



A-2791.06



A-2721

Art. No.	System Size	Description	Length	Pieces/Pkg
A-2791.06	2.5	for ulna shortening	144 mm	1
A-2721	2.5	for lag screws	144 mm	1

Depth Gauge



A-2730



A-2730.1

Art. No.	System Size	Description	Length	Pieces/Pkg
A-2730	2.5		151 mm	1
A-2730.1	2.5	caliper	149 mm	1

Handle with Quick Connector



Art. No.	Description	Length	For Drill Shaft End	Pieces/Pkg
A-2073	with twist cap	124 mm	AO Quick Coupling	1

Screwdriver Blade, Self-Holding

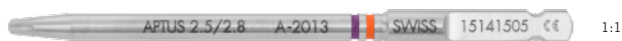

1:1

Art. No.	System Size	Description	Length	Shaft End	Pieces/Pkg
A-2013	2.5/2.8	HD7	75 mm	AO Quick Coupling	1

WRIST-10000021_v0 / 2017-10, Medartis AG, Switzerland. All technical data subject to alteration.

MANUFACTURER & HEADQUARTERS

Medartis AG | Hochbergerstrasse 60E | 4057 Basel/Switzerland
P +41 61 633 34 34 | F +41 61 633 34 00 | www.medartis.com

SUBSIDIARIES

Australia | Austria | Brazil | France | Germany | Mexico | New Zealand | Poland | UK | USA

For detailed information regarding our subsidiaries and distributors, please visit www.medartis.com

