

medartis

PRECISION IN FIXATION

SURGICAL TECHNIQUE

Radius and Ulna Shaft System 2.8



APTUS Forearm

Contents

3	Introduction
3	Product Materials
3	Indications
3	Contraindications
3	Color Coding
3	Possible Combination of Plates and Screws
3	Symbols
4	System Overview
5	Instrument Application
5	General Instrument Application
5	Sizing Templates
6	Drilling
7	Assigning the Screw Length
8	Thread Preparation with the Tap
9	Screw Pick-Up
10	Surgical Techniques
10	General Surgical Techniques
10	Lag Screw Technique
11	TriLock ^{PLUS}
12	Specific Surgical Technique
12	Radius and Ulna Shaft Plates
14	Explanation
15	TriLock Locking Technology
15	Correct Application of the TriLock Locking Technology
16	Correct Locking ($\pm 15^\circ$) of the TriLock Screws in the APTUS Radius and Ulna Shaft System 2.8
17	Implants, Instruments and Containers

For further information regarding the APTUS product line visit: www.medartis.com

Introduction

Product Materials

Plates	Pure titanium, titanium alloy
Screws	Titanium alloy
K-wires	Stainless steel
Instruments	Stainless steel, PEEK, aluminum, Nitinol, silicone or titanium
Containers	Stainless steel, aluminum, PEEK, polyphenylsulfone, polyurethane, silicone

Indications

APTUS Forearm

Fractures and osteotomies of the bones of the forearm

- Radius shaft plates
 - fractures and osteotomies of the radius shaft
- Ulna shaft plates
 - fractures and osteotomies of the ulna shaft

Contraindications

- Preexisting or suspected infection at or near the implantation site
- Known allergies and / or hypersensitivity to implant materials
- Inferior or insufficient bone quality to securely anchor the implant
- Patients who are incapacitated and / or uncooperative during the treatment phase
- Growth plates are not to be blocked with plates and screws

Color Coding

System Size	Color Code
2.8	Orange

Plates and Screws

Special implant plates and screws have their own color:

Implant plates blue	TriLock plates (locking)
Implant screws gold	Cortical screws (fixation)
Implant screws blue	TriLock screws (locking)

Possible Combination of Plates and Screws

Plates and screws can be combined within one system size:

2.8 TriLock Plates

2.8 Cortical Screws, HexaDrive 7

2.8 TriLock Screws, HexaDrive 7

Symbols

 HexaDrive

 TriLock screw hole on sizing templates

 TriLock^{PLUS} screw hole on sizing templates



System Overview

The implant plates of the APTUS Forearm Radius and Ulna Shaft System 2.8 are available in the following designs:

2.8 TriLock Radius Shaft Plates

2.8 TriLock Ulna Shaft Plates

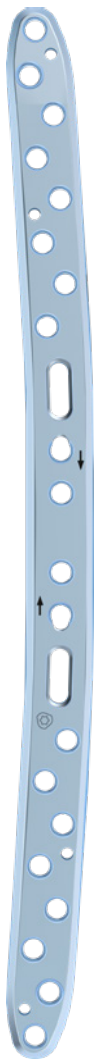

A-4857.04
2.8 TriLock
Radius Shaft Plate
22 Holes

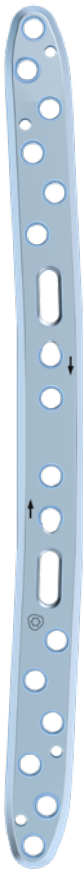

A-4857.03
2.8 TriLock
Radius Shaft Plate
18 Holes

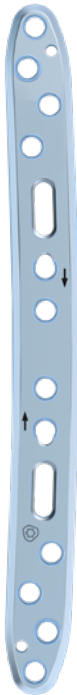

A-4857.02
2.8 TriLock
Radius Shaft Plate
14 Holes



A-4857.01
2.8 TriLock
Radius Shaft Plate
10 Holes

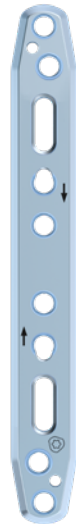

A-4857.11
2.8 TriLock
Ulna Shaft Plate
10 Holes

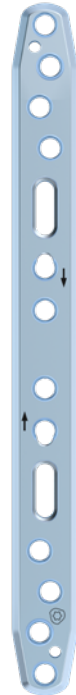

A-4857.12
2.8 TriLock
Ulna Shaft Plate
14 Holes



A-4857.13
2.8 TriLock
Ulna Shaft Plate
18 Holes

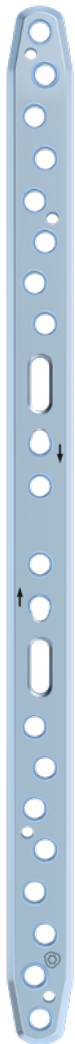

A-4857.14
2.8 TriLock
Ulna Shaft Plate
22 Holes

Instrument Application

General Instrument Application

Sizing Templates

Sizing templates facilitate the intra-operative selection of the appropriate implant.

Sizing templates for the Radius and Ulna Shaft System 2.8 are available according to chapter "Implants, Instruments and Containers".

The sizing templates feature symbols that indicate the type of the screw hole and its position on the respective implant:



for a TriLock screw hole (locking) using a TriLock or a cortical screw



for a TriLock^{PLUS} screw hole (locking / compression) using a TriLock or a cortical screw

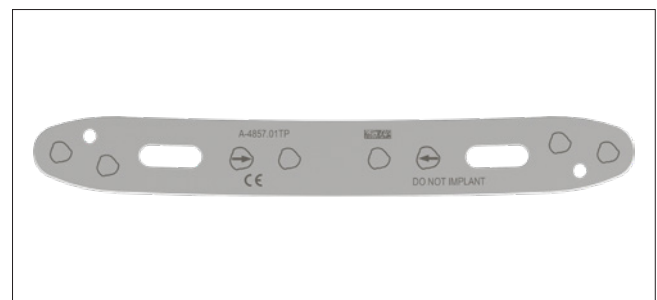

Sizing template with TriLock and TriLock^{PLUS} screw hole symbols

The article number of the sizing template (e.g. A-4857.01TP) corresponds to the article number of the sterile implant (e.g. A-4857.01S). The suffix TP stands for template.

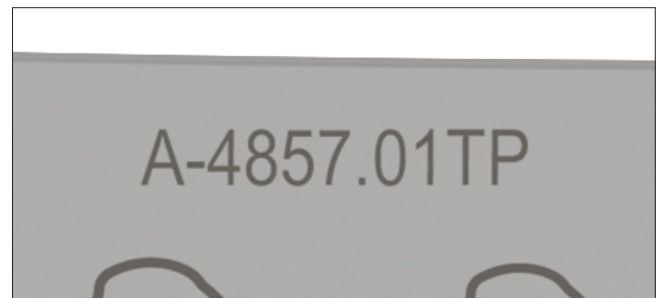

A-4857.01TP
Template for A-4857.01S

Use appropriate K-wires to temporarily fix the sizing template to the bone, if necessary.

Notice

Do not implant sizing templates.

Do not bend or cut sizing templates.

Drilling

Color-coded twist drills are available for every APTUS system size. All twist drills are color coded with a ring system.

System Size	Color Code
2.8	Orange

There are two different types of twist drills for the system size 2.8: The core hole drill is characterized by one colored ring. The gliding hole drill (for lag screw technique) is characterized by two colored rings.

Warning

The twist drill must always be guided by the drill guide (A-2026, A-2820) or the self-holding drill sleeve (A-2826). This prevents damage to the screw hole and protects the surrounding tissue from direct contact with the drill. The drill guide also serves to limit the pivoting angle.



A-3832
Core hole drill with \varnothing 2.35 mm = one colored ring



A-3834
Gliding hole drill with \varnothing 2.9 mm = two colored rings



A-2026
2.5 / 2.8 Drill Guide, TriLock^{PLUS}



A-2820
2.8 Drill Guide



A-2826
2.8 Drill Sleeve, Self-Holding

After positioning the plate, insert the drill guide or the self-holding drill sleeve and the twist drill into the screw hole.

The end with one orange marking of the double-ended drill guide (A-2820) can be used for all screw holes and for the insertion of independent screws (e.g. fragment fixation with screws alone).

The one end of the double-ended drill guide for TriLock^{PLUS} (A-2026) can be used for all screw holes. The other end marked with the arrow is used for the TriLock^{PLUS} holes only.

The self-holding drill sleeve (A-2826) can be locked with a clockwise turn in the TriLock holes of the plate (no more than $\pm 15^\circ$). It thus performs all of the functions of a drill guide without the need to be held.

Warning

For TriLock plates ensure that the screw holes are predrilled with a pivoting angle of no more than $\pm 15^\circ$. For this purpose, the drill guides show a limit stop of $\pm 15^\circ$. A predrilled pivoting angle of $> 15^\circ$ no longer allows the TriLock screws to correctly lock in the plate.

Assigning the Screw Length

The depth gauge (A-2031) is used to assign the ideal screw length for use in monocortical or bicortical screw fixation of TriLock screws and cortical screws.

Retract the slider of the depth gauge.

The depth gauge caliper has a hooked tip that is either inserted to the bottom of the hole or is used to catch the far cortex of the bone. When using the depth gauge, the caliper stays static and only the slider is adjusted.

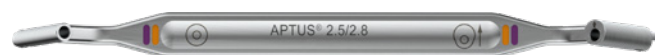
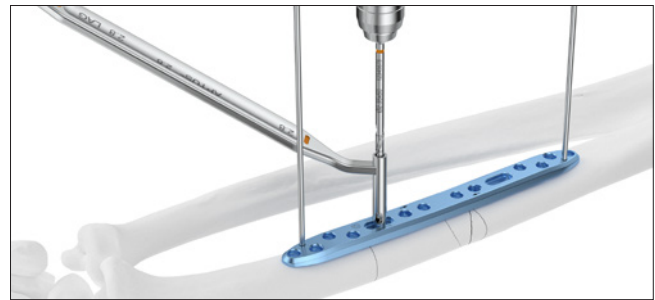

A-2026
2.5 / 2.8 Drill Guide, TriLock^{PLUS}

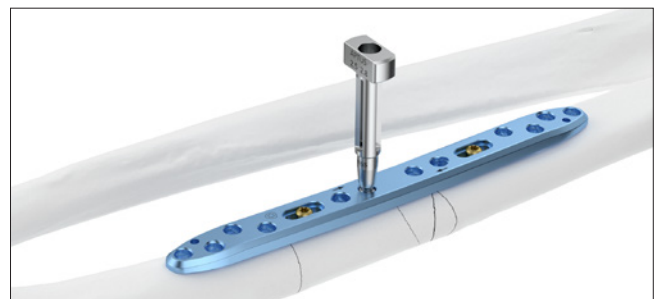

A-2031
2.0-2.8 Depth Gauge

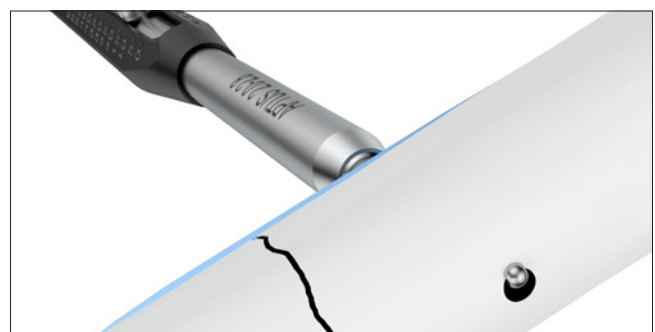

To assign the screw length, place the distal end of the slider onto the implant plate or directly onto the bone (e.g. for fracture fixation with lag screws).

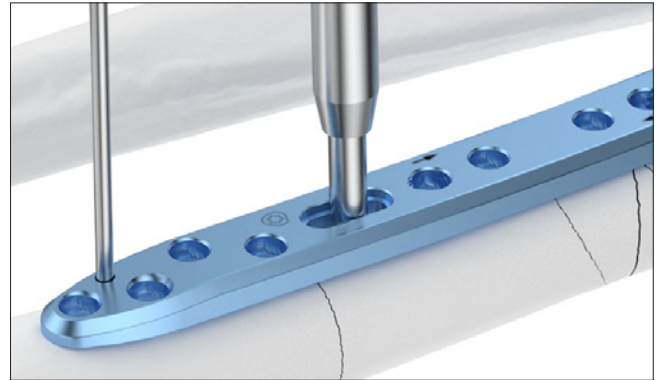

The ideal screw length for the assigned drill hole can be read on the scale of the depth gauge.



Thread Preparation with the Tap

Caution

All APTUS screws are self-tapping. In the case of very hard bone, especially in the shaft region of the radius or ulna, it can be indicated to reduce the insertion torque of the 2.8 screws by using the 2.8 tap (A-3839).



A-3839
2.8 Tap



A-2077
Handle with Quick Connector, AO

After drilling a core hole with the core hole drill (A-3832, one orange ring), create a thread for the screw using the 2.8 tap (A-3839) together with the handle (A-2077).

Assign the screw length and insert the corresponding screw with the screwdriver (screwdriver blade A-2013 with handle A-2077).

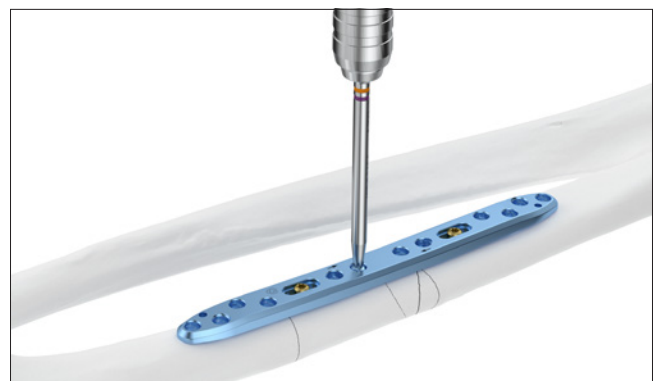

Screw Pick-Up

The screwdriver blade (A-2013) features the patented HexaDrive self-holding system.



A-2013
2.5 / 2.8 Screwdriver Blade, HD7, AO



A-2077
Handle with Quick Connector, AO

To remove the screws from the implant container, insert the appropriately color-coded screwdriver blade perpendicularly into the screw head of the desired screw and pick up the screw with axial pressure.

Notice

The screw will not hold without axial pressure.

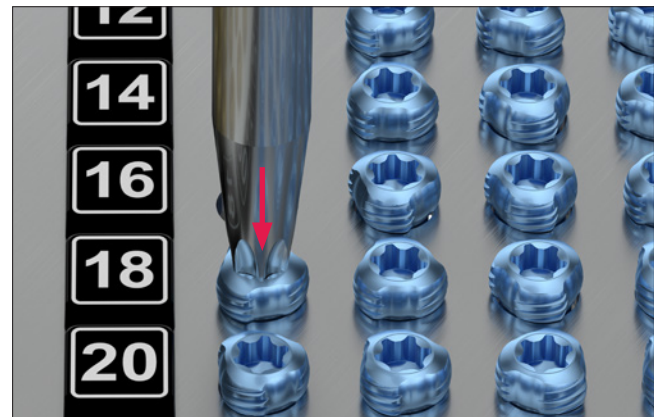

Caution

Vertically extract the screw from the compartment. Picking up the screw repeatedly may lead to permanent deformation of the self-retaining area of the HexaDrive inside the screw head. Therefore, the screw may no longer be able to be picked up correctly. In this case, a new screw has to be used.

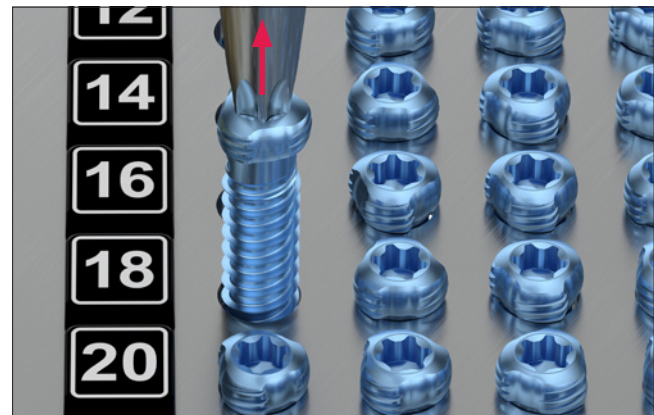

Notice

Check the screw length and diameter at the scale of the measuring module. The screw length is determined at the end of the screw head.



Surgical Techniques

General Surgical Techniques

Lag Screw Technique

Warning

Incorrect application of the lag screw technique may result in postoperative loss of reduction.

1. Drilling the gliding hole

Drill the gliding hole using the twist drill marked with two orange rings (A-3834, Ø 2.9 mm) in combination with the end of the drill guide (A-2820) labeled with "LAG". Drill perpendicular to the fracture line.

Do not drill further than to the fracture line.



2. Drilling the core hole

After fracture reduction, insert the other end of the drill guide (A-2820) into the drilled gliding hole and use the twist drill for core holes with one orange ring (A-3832, Ø 2.35 mm) to drill the core hole.



3. Compressing the fracture

Compress the fracture with the corresponding cortical screw (A-5800.xx).

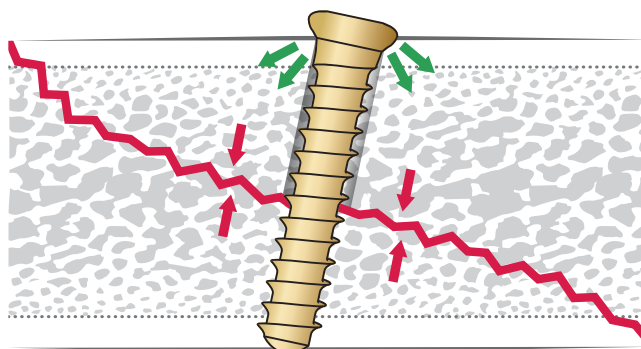

4. Optional steps before compression

If required, use the countersink (A-3835) to create a recess in the bone for the screw head.

Caution

Use the handle (A-2077) instead of a power tool to reduce the risk of countersinking too far through the near cortex.



TriLock^{PLUS}

TriLock^{PLUS} holes are available on all radius and ulna shaft plates (A-4857.01–04, A-4857.11–14).

TriLock^{PLUS} allows for 1 mm compression and angular stable locking in one step.

For this technique, a TriLock screw, the 2.5/2.8 drill guide TriLock^{PLUS} (A-2026) and a plate with a TriLock^{PLUS} hole are required. The TriLock^{PLUS} holes and the respective end of the drill guide are both marked with an arrow indicating the direction of the compression. Before using a TriLock^{PLUS} hole, ensure that there is no fixation on the TriLock^{PLUS} side, and fix the plate with at least one TriLock screw on the opposite side of the fracture or osteotomy line.

1. Positioning the drill guide in the plate

Following the direction of the compression, insert the 2.5 / 2.8 drill guide TriLock^{PLUS} perpendicular to the plate. The arrow on the drill guide and the plate both indicate the direction of the compression.

Warning

Correct compression is only achieved if the drill guide is inserted in a 90° angle into the plate.

2. Drilling through the drill guide TriLock^{PLUS}

Use the twist drill for core holes with one orange ring (A-3832, Ø 2.35 mm) to completely drill through the bone (bicortically).

3. Inserting the screw and locking in final position

Insert a TriLock screw into the predrilled hole. Axial compression starts as soon as the screw head touches the plate. The final position is reached when the screw is locked into the TriLock screw hole.

TriLock^{PLUS} holes can also be used as conventional TriLock holes allowing for multidirectional ($\pm 15^\circ$) and angular stable locking with TriLock screws or for the insertion of cortical screws. For conventional drilling, use the respective end of the drill guide (A-2026, A-2820), see also chapter "Drilling".

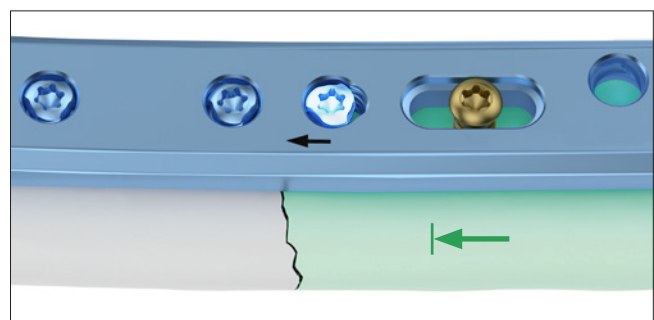
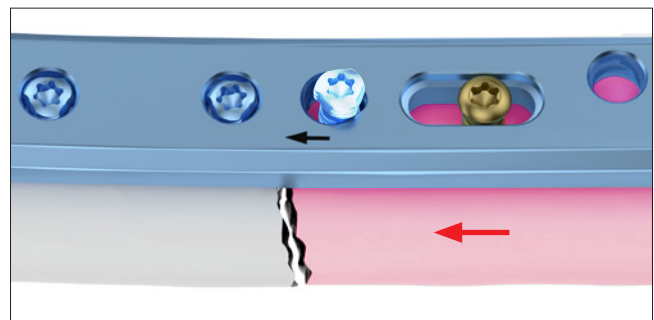
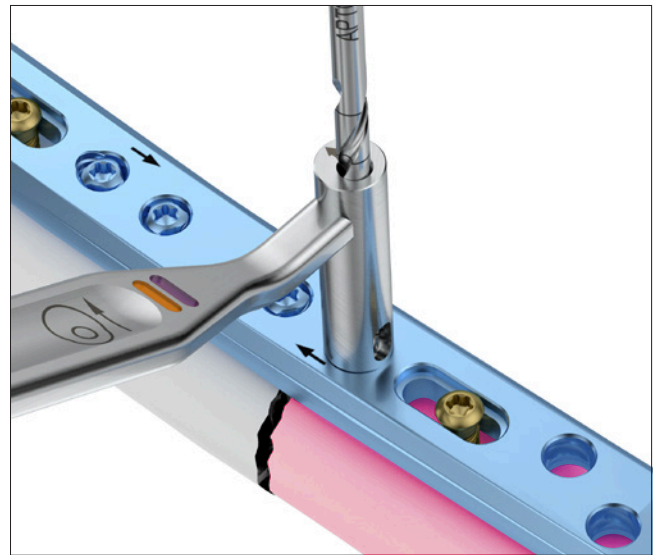

Specific Surgical Technique

Radius and Ulna Shaft Plates

1. Positioning the plate

After reduction of the fracture, select the appropriate radius or ulna shaft plate (A-4857.xx) with the correct length. Position the plate centrally over the fracture, ideally leaving three screw holes distal and proximal to the fracture.

Caution

The plates are designed to fit both the left or the right forearms. Rotate the plates by 180° for anatomical fit.

For temporary plate fixation, 1.6 mm K-wires (A-5040.41, A-5042.41) or olive K-wires (A-5045.41/1) may be used.

Notice

Prior to placement of the plate, a lag screw fixation across the major fracture fragments may be performed (see chapter "Lag Screw Technique").

2. Fixing the plate

Drill a core hole through the center of the oblong hole using the core hole drill with \varnothing 2.35 mm (A-3832) with the corresponding end of the drill guide (A-2820).

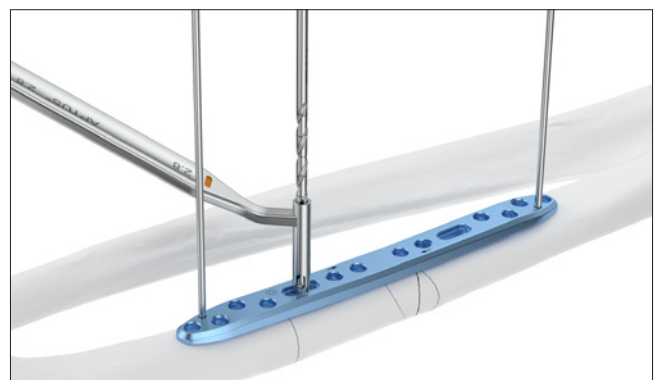
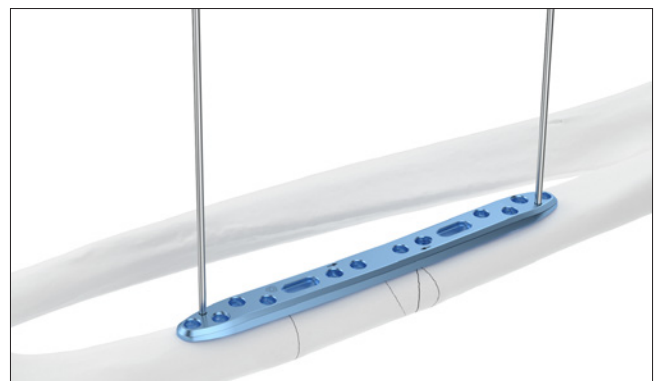

Assign the screw length using the depth gauge (A-2031).

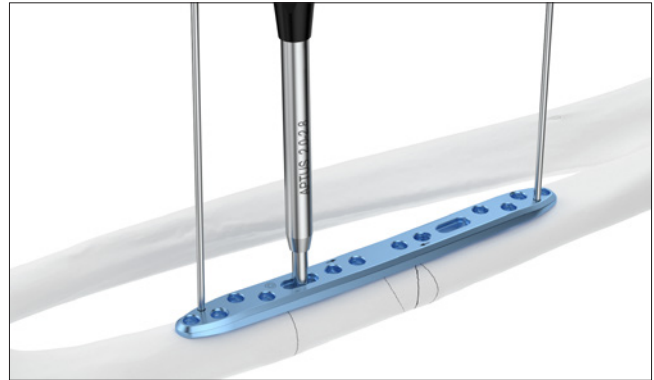

Insert a cortical screw \varnothing 2.8 mm (A-5800.xx). The cortical screw pulls the bone to the plate.

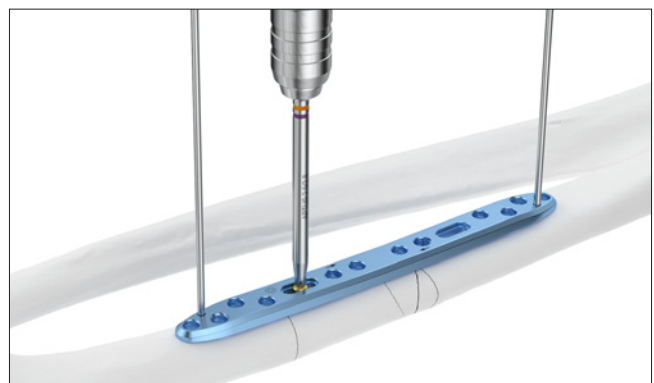

Drill, assign the screw length and insert a cortical screw \varnothing 2.8 mm (A-5800.xx) in the second oblong hole.

Use intraoperative X-ray control to verify the correct plate position.

Notice

If the plate position needs adjustment: remove the K-wires, slightly loosen the cortical screw in the oblong hole, readjust the position of the plate and retighten the cortical screw.

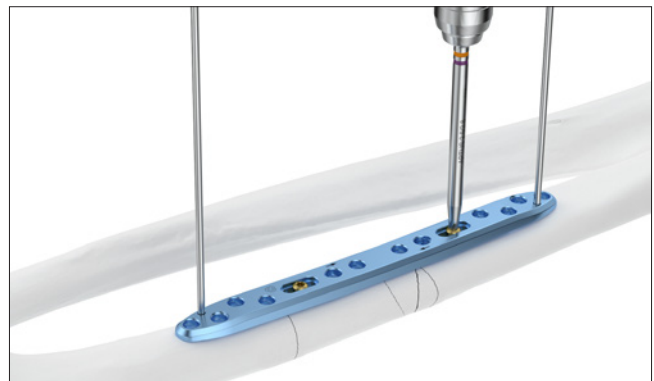

Drill, assign the screw length and insert TriLock screws \varnothing 2.8 mm (A-5850.xx) into the remaining screw holes, starting with the holes next to the fracture.

Remove all K-wires, if previously placed.

Warning

If a TriLock^{PLUS} hole is used to compress the fracture, the TriLock^{PLUS} hole should be used before placing any other TriLock screws on the same side of the fracture line (see chapter "TriLock^{PLUS}").

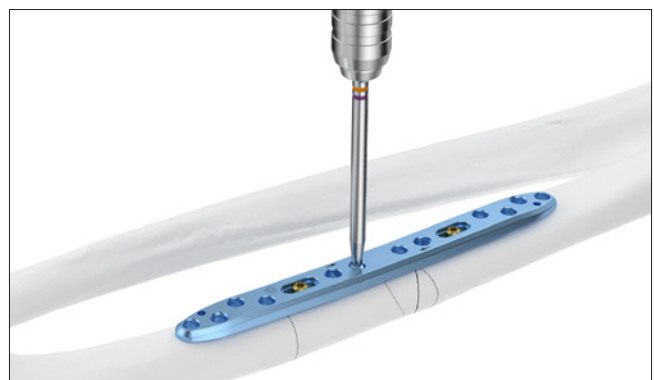

Explantation

Explantation of Forearm Plates

1. Removing the screws

Unlock all screws and remove them.

The order in which the screws are removed is not relevant.

In case the plate sticks to the bone, use a periosteal elevator to carefully lift and detach it from the bone.

Caution

When removing the screws, ensure that any bone ingrowth in the screw head has been removed, that the screwdriver/screw head connection is aligned in axial direction, and that a sufficient axial force is used between blade and screw.

TriLock Locking Technology

Correct Application of the TriLock Locking Technology

The screw is inserted through the plate hole into a predrilled canal in the bone. An increase of the tightening torque will be felt as soon as the screw head gets in contact with the plate surface.

This indicates the start of the «Insertion Phase» as the screw head starts entering the locking zone of the plate (section "A" in the diagram). Afterwards, a drop of the tightening torque

occurs (section "B" in the diagram). Finally the actual locking is initiated (section "C" in the diagram) as a friction connection is established between screw and plate when tightening firmly.

The torque applied during fastening of the screw is decisive for the quality of the locking as described in section "C" of the diagram.

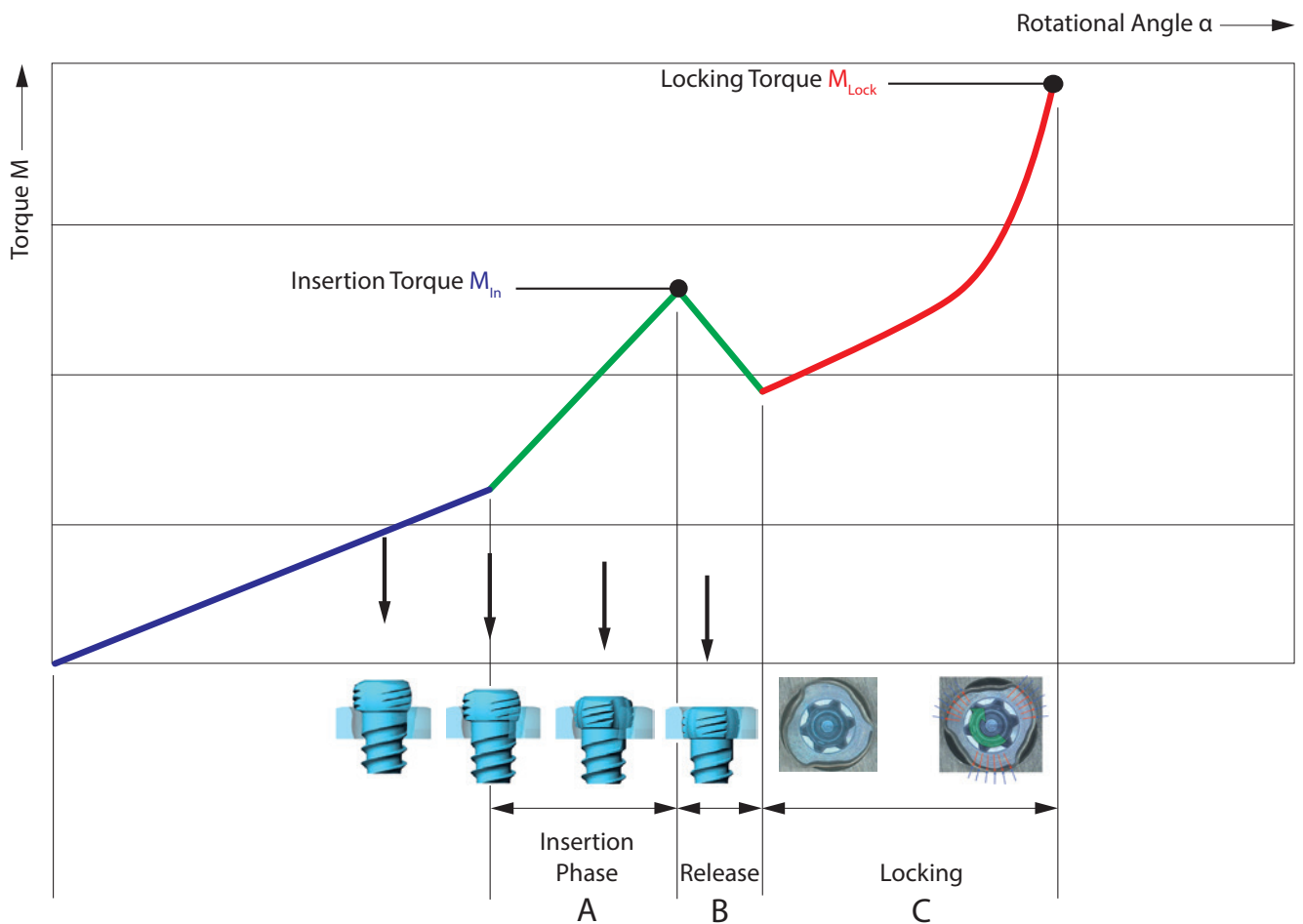

Correct Locking ($\pm 15^\circ$) of the TriLock Screws in the APTUS Radius and Ulna Shaft System 2.8

Correct locking occurs only when the screw head is locked flush with the locking contour (fig. 1 and 3).

However, if there is still a noticeable protrusion (fig. 2 and 4), the screw head has not completely reached the locking position. In this case, the screw has to be retightened to obtain full penetration and proper locking. In case of poor bone

quality, a slight axial pressure might be necessary to achieve proper locking.

After having reached the locking torque (MLock), do not further tighten the screw, otherwise the locking function cannot be guaranteed anymore.

Correct: LOCKED



Figure 1

Incorrect: UNLOCKED

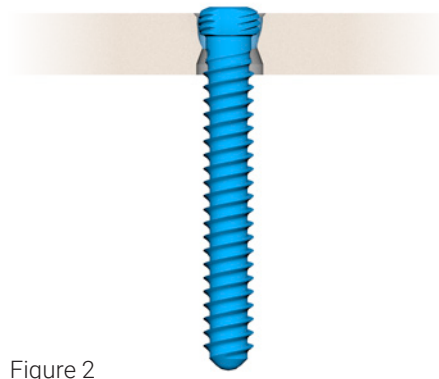

Figure 2

Correct: LOCKED

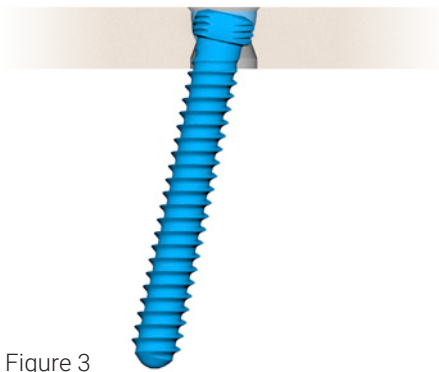

Figure 3

Incorrect: UNLOCKED

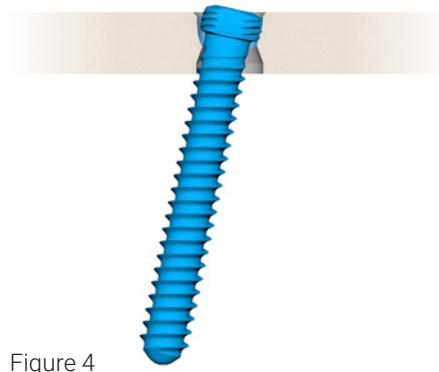

Figure 4

Implants, Instruments and Containers

2.8 Cortical Screws, HexaDrive 7

Material: Titanium alloy (ASTM F136)



Length	Art. No.	STERILE	Pieces / Pkg	Art. No.	Pieces / Pkg
8 mm	A-5800.08/1	A-5800.08/1S	1	A-5800.08	5
10 mm	A-5800.10/1	A-5800.10/1S	1	A-5800.10	5
12 mm	A-5800.12/1	A-5800.12/1S	1	A-5800.12	5
14 mm	A-5800.14/1	A-5800.14/1S	1	A-5800.14	5
16 mm	A-5800.16/1	A-5800.16/1S	1	A-5800.16	5
18 mm	A-5800.18/1	A-5800.18/1S	1	A-5800.18	5
20 mm	A-5800.20/1	A-5800.20/1S	1	A-5800.20	5
22 mm	A-5800.22/1	A-5800.22/1S	1	A-5800.22	5
24 mm	A-5800.24/1	A-5800.24/1S	1	A-5800.24	5

2.8 TriLock Screws, HexaDrive 7

Material: Titanium alloy (ASTM F136)

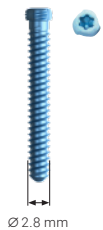

Length	Art. No.	STERILE	Pieces / Pkg	Art. No.	Pieces / Pkg
8 mm	A-5850.08/1	A-5850.08/1S	1	A-5850.08	5
10 mm	A-5850.10/1	A-5850.10/1S	1	A-5850.10	5
12 mm	A-5850.12/1	A-5850.12/1S	1	A-5850.12	5
14 mm	A-5850.14/1	A-5850.14/1S	1	A-5850.14	5
16 mm	A-5850.16/1	A-5850.16/1S	1	A-5850.16	5
18 mm	A-5850.18/1	A-5850.18/1S	1	A-5850.18	5
20 mm	A-5850.20/1	A-5850.20/1S	1	A-5850.20	5
22 mm	A-5850.22/1	A-5850.22/1S	1	A-5850.22	5
24 mm	A-5850.24/1	A-5850.24/1S	1	A-5850.24	5

2.8 TriLock Radius Shaft Plates

Material: Titanium (ASTM F67)
Plate thickness: 3.4 mm

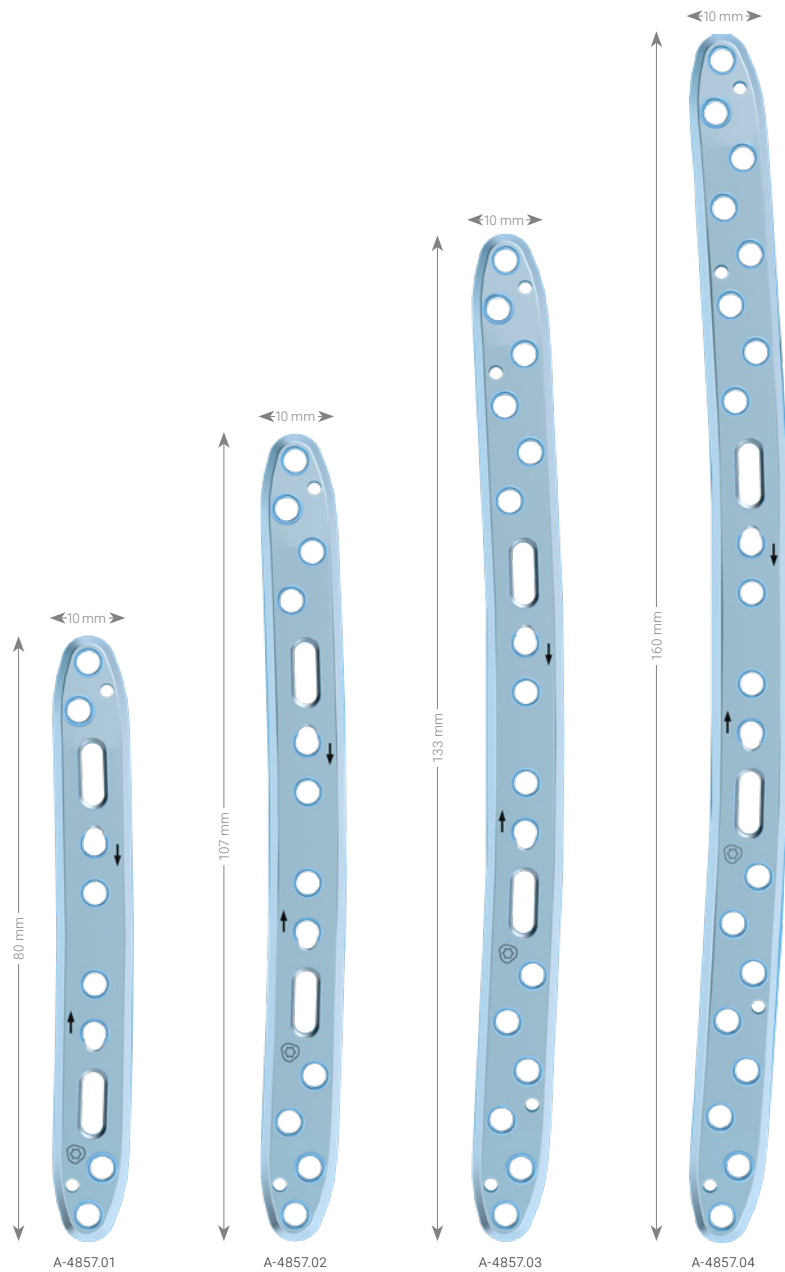

Art. No.	STERILE	Template	Description	Holes	Pieces / Pkg
A-4857.01	A-4857.01S	A-4857.01TP	TriLock ^{PLUS}	10	1
A-4857.02	A-4857.02S	A-4857.02TP	TriLock ^{PLUS}	14	1
A-4857.03	A-4857.03S	A-4857.03TP	TriLock ^{PLUS}	18	1
A-4857.04	A-4857.04S	A-4857.04TP	TriLock ^{PLUS}	22	1

2.8 TriLock Ulna Shaft Plates

Material: Titanium (ASTM F67)
Plate thickness: 3.4 mm

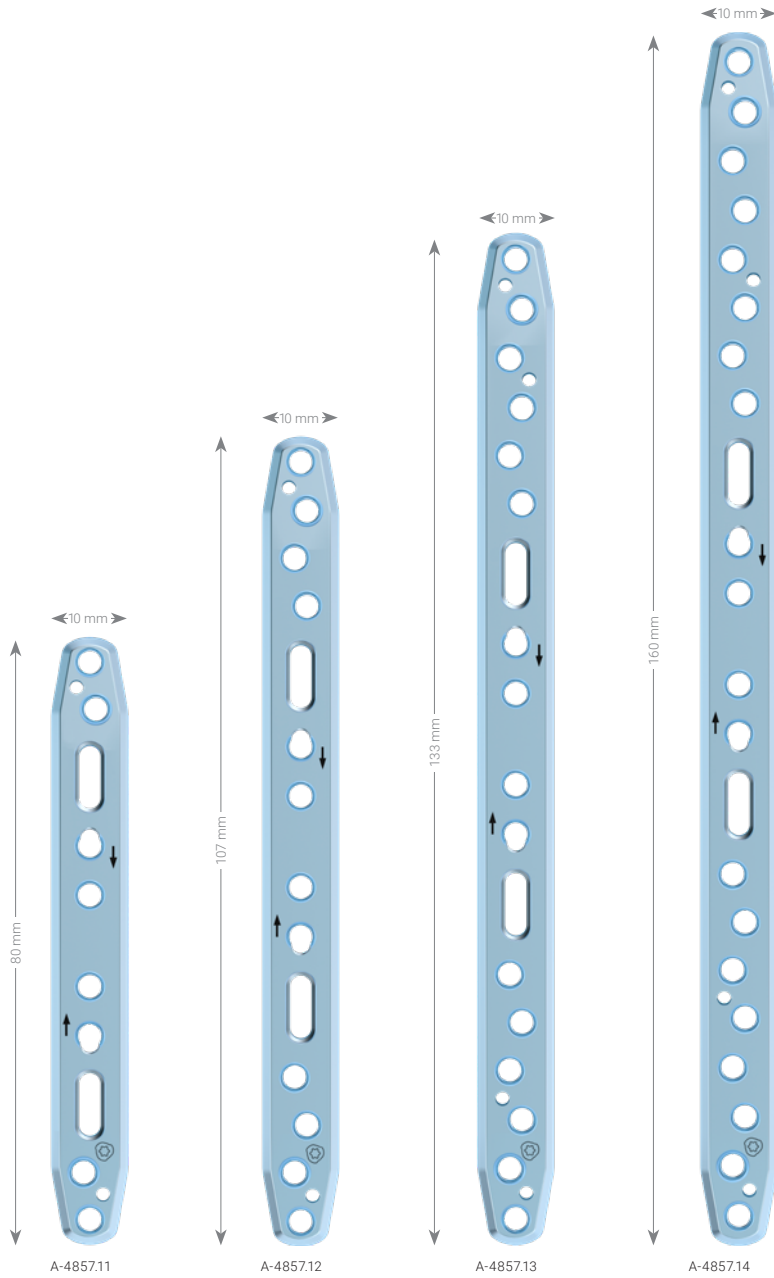

Art. No.	STERILE	Template	Description	Holes	Pieces / Pkg
A-4857.11	A-4857.11S	A-4857.11TP	TriLock ^{PLUS}	10	1
A-4857.12	A-4857.12S	A-4857.12TP	TriLock ^{PLUS}	14	1
A-4857.13	A-4857.13S	A-4857.13TP	TriLock ^{PLUS}	18	1
A-4857.14	A-4857.14S	A-4857.14TP	TriLock ^{PLUS}	22	1

Twist Drill Ø 2.35 mm



Art. No.	STERILE	Stop	Length	Shaft End	Pieces / Pkg
A-3832	A-3832S	50 mm	101 mm	AO Quick Coupling	1

Twist Drill Ø 2.9 mm (for Gliding Hole)



Art. No.	STERILE	Stop	Length	Shaft End	Pieces / Pkg
A-3834	A-3834S	10 mm	61 mm	AO Quick Coupling	1

Countersink for Cortical Screws



Art. No.	STERILE	Ø	Length	Shaft End	Pieces / Pkg
A-3835	A-3835S	3.7 mm	45 mm	AO Quick Coupling	1

Tap Ø 2.8



Art. No.	Length	Thread Length	Shaft End	Pieces / Pkg
A-3839	110 mm	75 mm	AO Quick Coupling	1

K-Wires, Stainless Steel



Art. No.	STERILE	Ø	Description	Length	Pieces / Pkg
A-5040.41		1.6 mm	trocar	150 mm	10
	A-5040.41/2S	1.6 mm	trocar	150 mm	2
A-5042.41		1.6 mm	lancet	150 mm	10
	A-5042.41/2S	1.6 mm	lancet	150 mm	2

Olive K-Wire, Stainless Steel

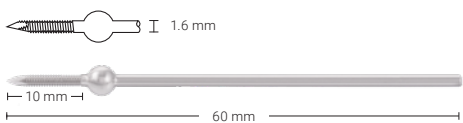

Art. No.	STERILE	Ø	Length	Thread Length	Pieces / Pkg
A-5045.41/1		1.6 mm	60 mm	10 mm	1
	A-5045.41/2S	1.6 mm	60 mm	10 mm	2

Drill Guides



Art. No.	System Size	Description	Length	Pieces / Pkg
A-2026	2.5 / 2.8	TriLock ^{PLUS}	146 mm	1
A-2820	2.8	for core and gliding hole	146 mm	1

Drill Sleeve



Art. No.	System Size	Description	Length	Pieces / Pkg
A-2826	2.5 / 2.8	self-holding	34 mm	1

Depth Gauge



Art. No.	System Size	Length	Pieces / Pkg
A-2031	2.0 – 2.8	189 mm	1

Handle with Quick Connector



Art. No.	Length	for Shaft End	Pieces / Pkg
A-2077	129 mm	AO Quick Coupling	1

Screwdriver Blade, Self-Holding



HD7

Art. No.	System Size	Interface	Length	Shaft End	Pieces / Pkg
A-2013	2.5 / 2.8	HD7	75 mm	AO Quick Coupling	1

Cases, Trays

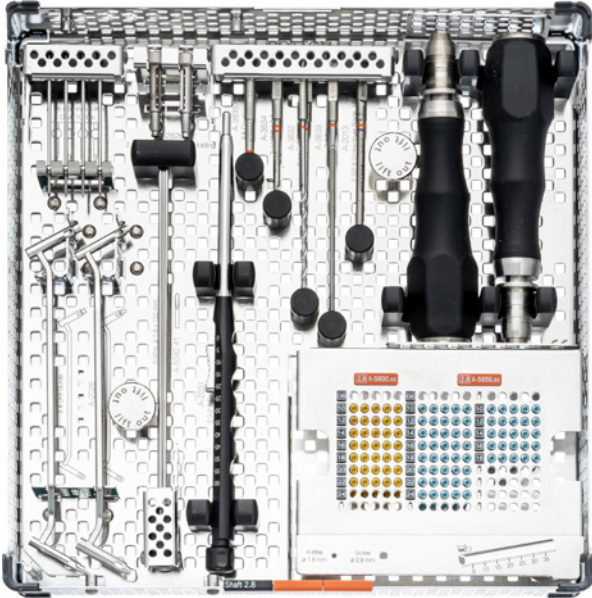

A-6607.001 with A-6607.015 and A-6607.010
(excl. implants and instruments)

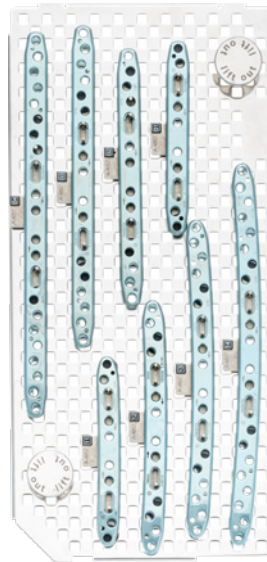

A-6607.006
(excl. implants)

Art. No.	Description	Dimensions (W x L x H)	Pieces / Pkg
A-6607.001	case APTUS Forearm 2.8	240 x 240 x 54 mm	1
A-6607.006	plate tray APTUS Forearm 2.8	114 x 334 x 20 mm	1
A-6607.010	screw tray APTUS Forearm 2.8	117 x 95 x 46 mm	1
A-6607.015	instrument tray APTUS Forearm 2.8	234 x 234 x 46 mm	1
M-6727	lid for implant and instrument case, 240x240mm	240 x 240 mm	1

Articles available on request

A-5040.41/1

A-5042.41/1

R_FOREARM-01010001_v1 / © 2022-09, Medartis AG, Switzerland. All technical data subject to alteration.

MANUFACTURER & HEADQUARTERS

Medartis AG | Hochbergerstrasse 60E | 4057 Basel / Switzerland
P +41 61 633 34 34 | F +41 61 633 34 00 | www.medartis.com

SUBSIDIARIES

Australia | Austria | Brazil | France | Germany | Japan | Mexico | New Zealand | Poland | Spain | UK | USA

For detailed information regarding our subsidiaries and distributors, please visit www.medartis.com



Disclaimer: This information is intended to demonstrate the Medartis portfolio of medical devices. A surgeon must always rely on her or his own professional clinical judgement when deciding whether to use a particular product when treating a particular patient. Medartis is not giving any medical advice. The devices may not be available in all countries due to registration and/or medical practices. For further questions, please contact your Medartis representative (www.medartis.com). This information contains products with CE and/or UKCA marking. All pictures shown are for illustration purposes only and may not be an exact representation of the product. For US only: Federal law restricts this device to sale by or on the order of a physician.